

# Die früh- und hochmittelalterlichen Bestattungen von Gumefens/Sus Fey (Freiburg, Schweiz)

Die Ausgrabungen von 1979 bis 1980

Gabriele Graenert

mit Beiträgen von

Christiane Hillenbrand-Unmüssig

Bruno Kaufmann

Marcel Mundschin

Christina Papageorgopoulou

Antoinette Rast-Eicher

Viera Trancik Petitpierre

Alexander Voûte

Freiburg 2015

Service archéologique de l'État de Fribourg

Amt für Archäologie des Kantons Freiburg



Schweizerische Eidgenossenschaft  
Confédération suisse  
Confederazione Svizzera  
Confederaziun svizra

Bundesamt für Strassen ASTRA  
Office fédéral des routes OFROU  
Ufficio federale delle strade USTRA

# Gesamtbestand der Grabpläne

(M. 1:20)

Für nicht abgebildete Gräber existiert kein Plan. Einige Grabpläne sind als Teil von Ensembles nicht in der Nummernfolge, sondern zusammen mit anderen Plänen gemäss folgender Korrelationsliste abgebildet:

31-32 mit 17; 46 mit 112; 51 und 55 mit 43; 58 mit 36; 59-60 mit 38; 61 mit 57; 76-77 und 81 mit 67; 85-86 mit 82; 117 mit 110; 124 mit 119; 128 mit 123; 132 mit 103; 133-134 und 136-137 mit 130; 139 mit 38; 157 mit 144; 158 mit 107; 175 mit 169; 181 mit 177; 187 mit 169; 188 mit 168; 197 und 203 mit 149; 209 mit 202; 213 mit 149; 214 mit 201; 215 mit 149; 219-220 mit 216; 228 mit 145; 243 mit 239; 263 mit 231; 265 und 270 mit 258; 271 mit 253; 286 mit 273; 299 mit 293; 300 mit 289; 301 mit 293; 325 mit 253; 335 mit 329; 353 mit 235; 354 und 359 mit 350; 381 mit 275.

Grab 1

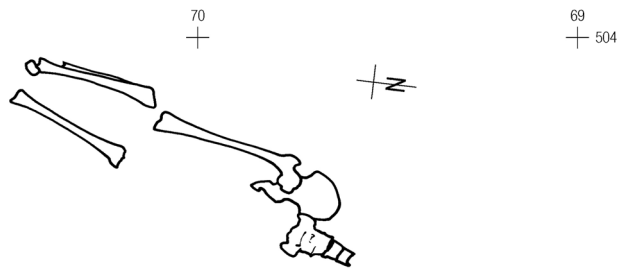

Grab 2



Grab 3

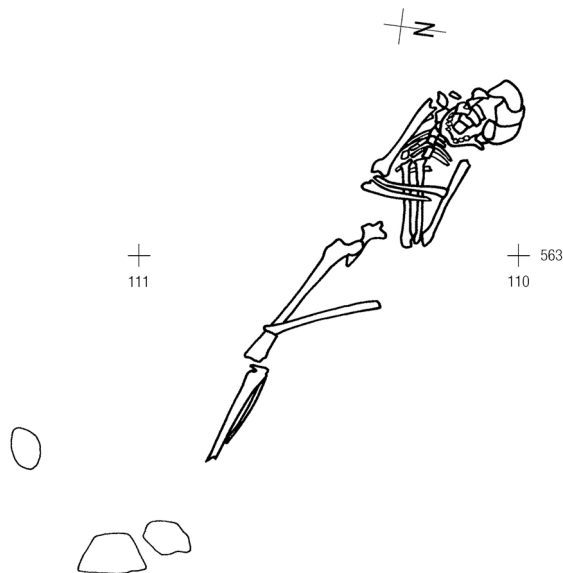

Gräber 5/6

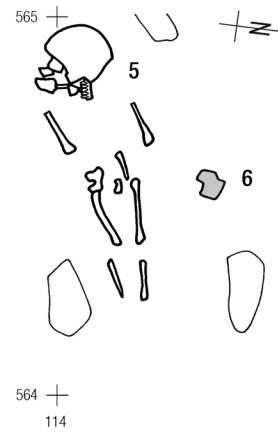

Grab 7



Grab 8

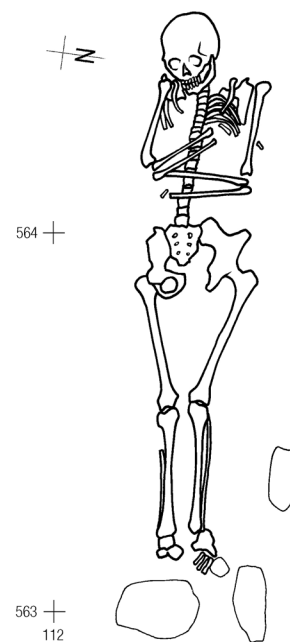

Grab 9

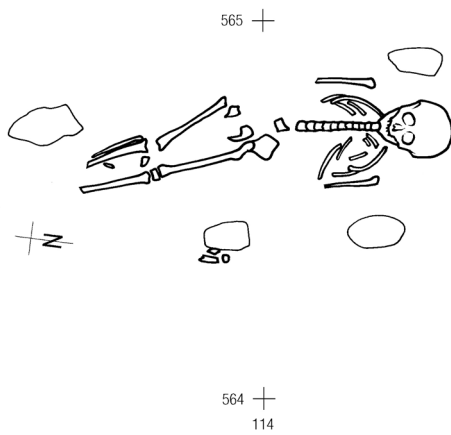

Gräber 10/11

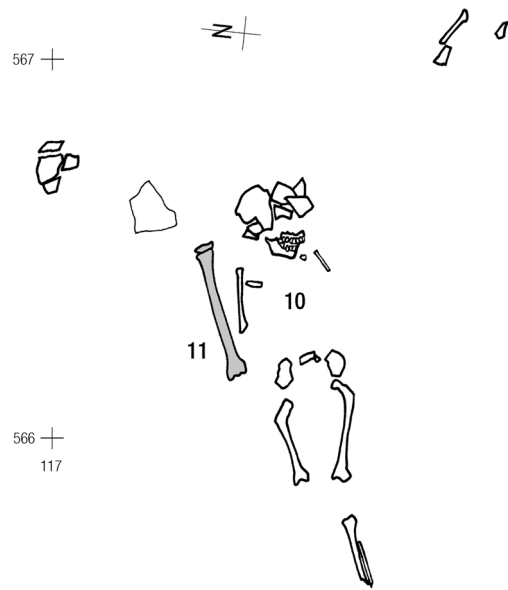

Grab 12

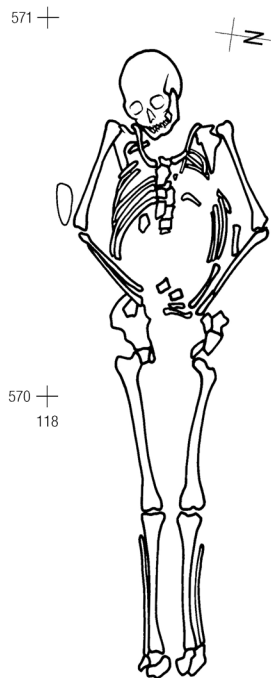

Gräber 13/14

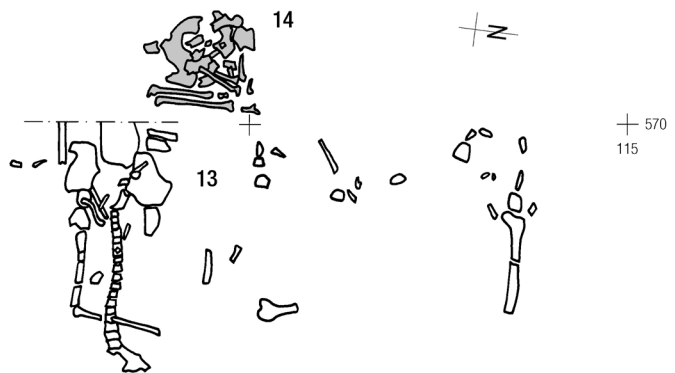

Gräber 15/31/32

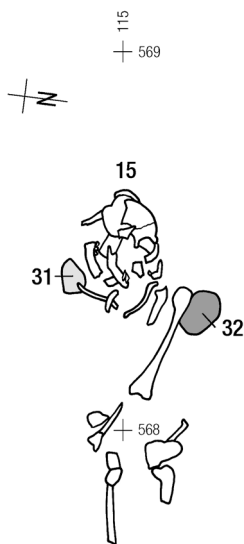

Grab 16

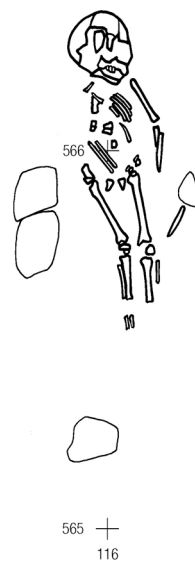



Gräber 18/20

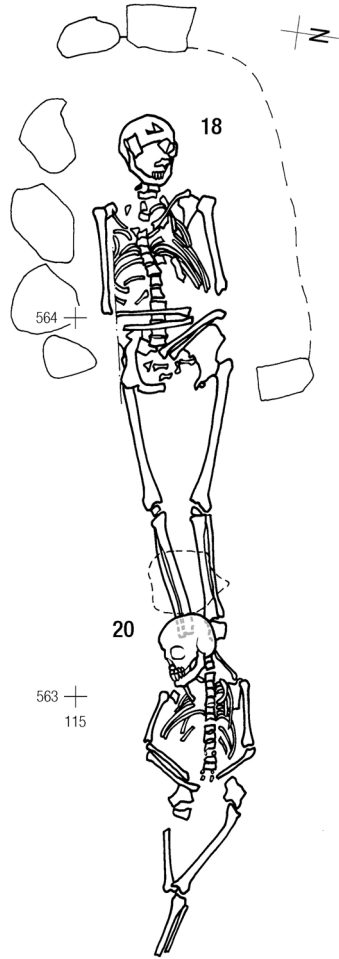

Grab 19

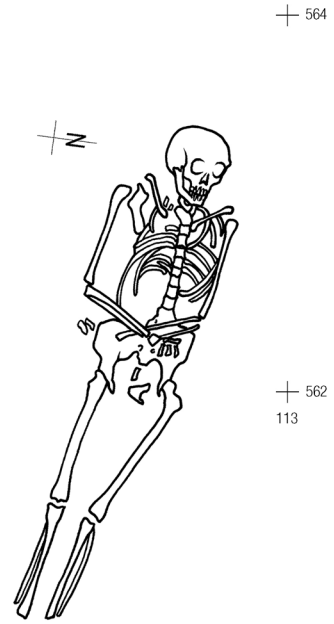

Gräber 23/24

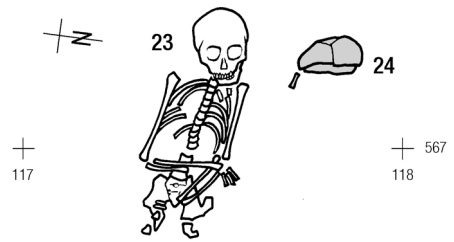

Gräber 21/22

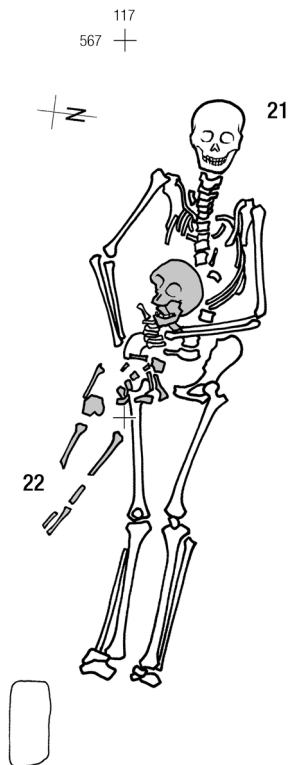

Grab 25

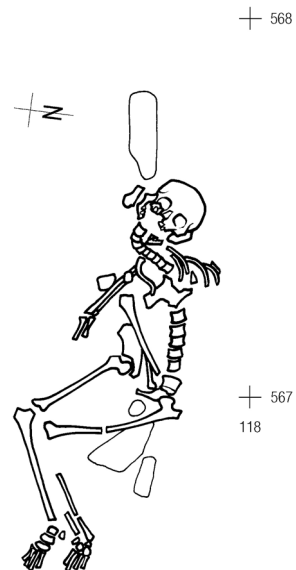

Grab 26

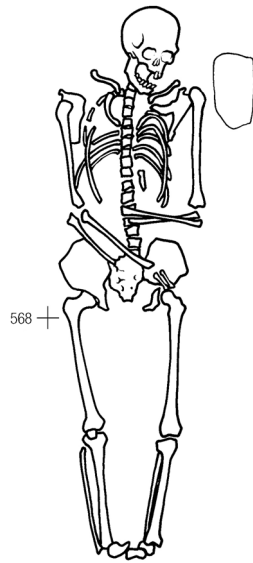

Grab 29

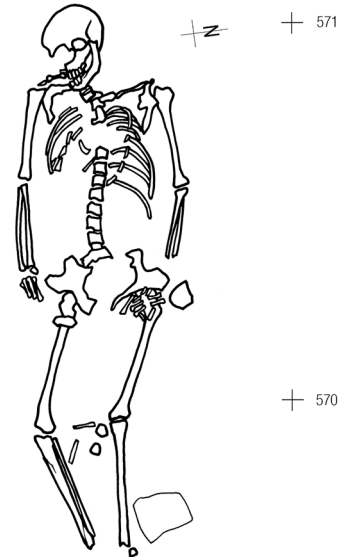

Grab 27



Gräber 30/33

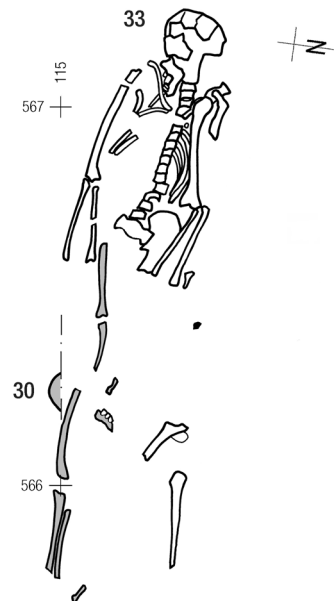

Grab 28

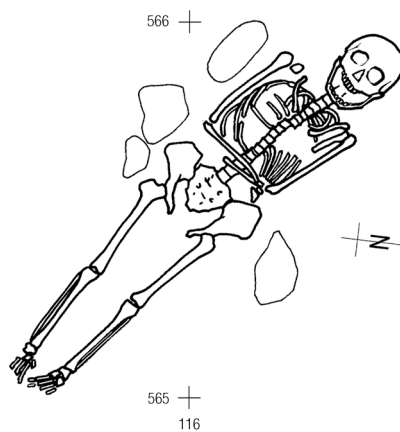

Grab 34

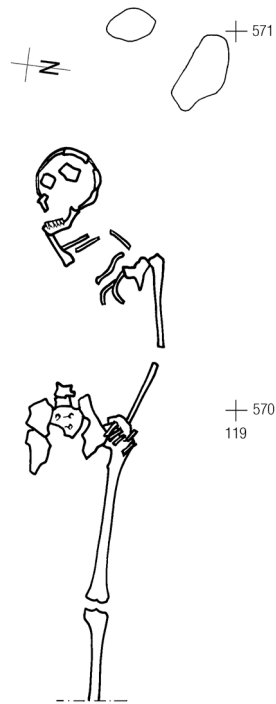

Grab 35

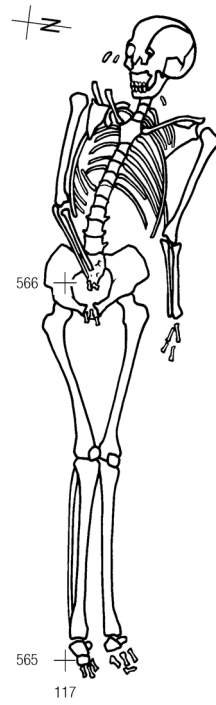

Gräber 36/37/58

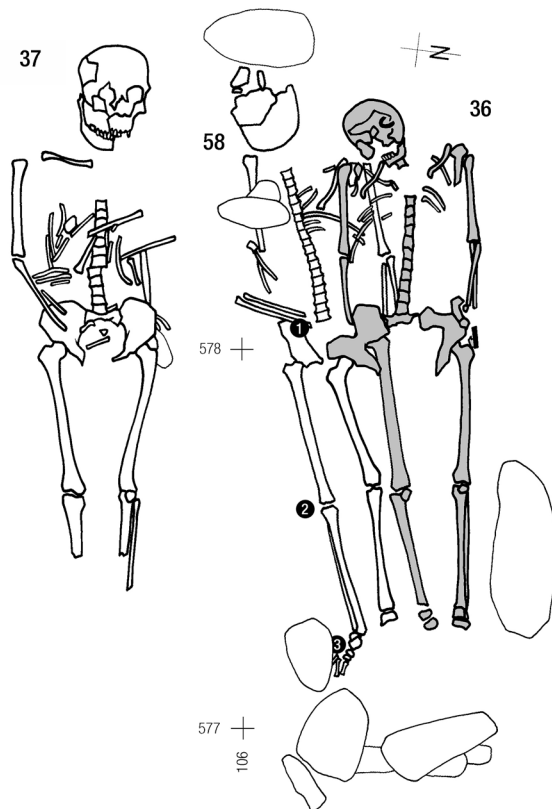

Gräber 38/59/60/139

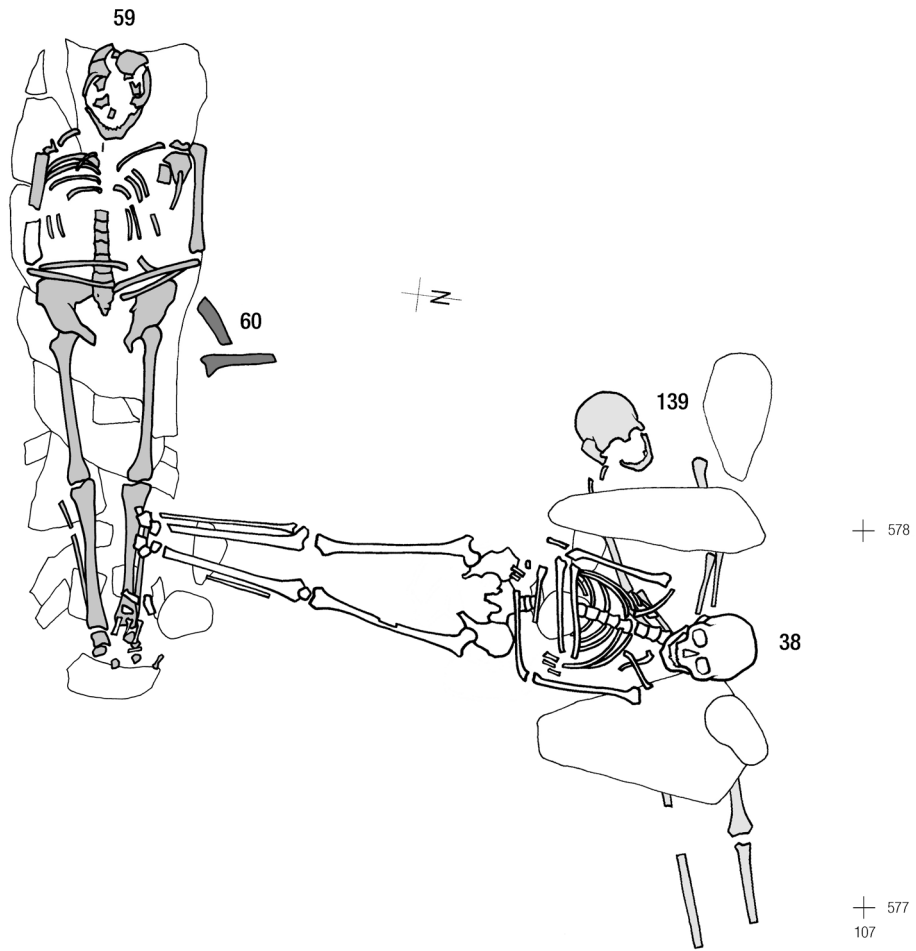

Grab 39

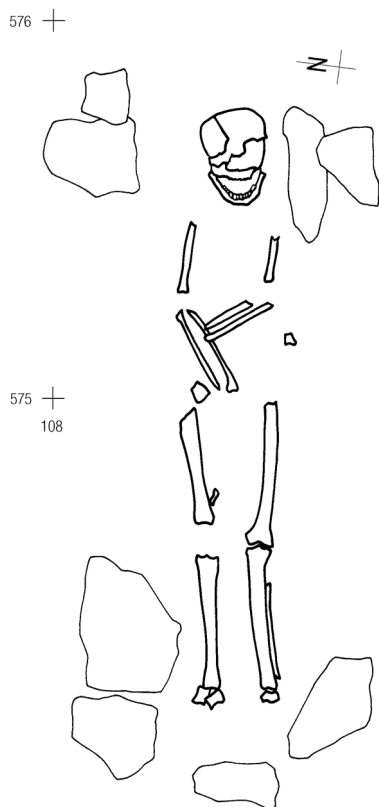

Grab 40

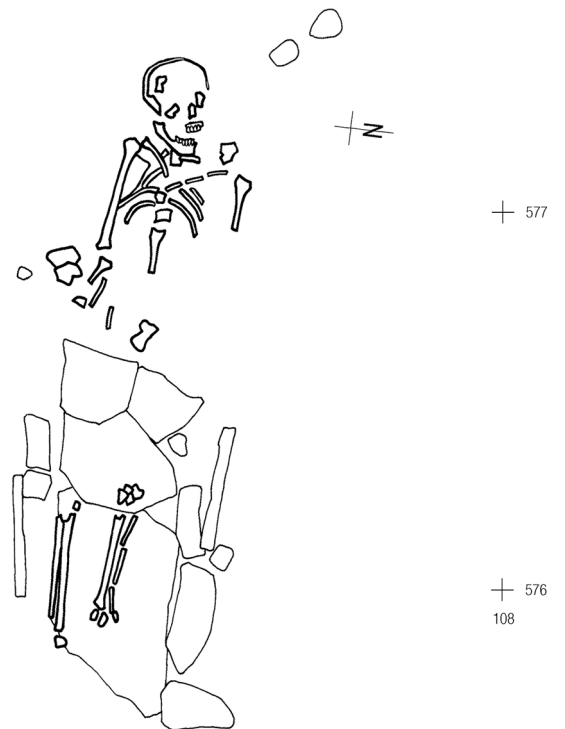

Gräber 43/51/55



Grab 44

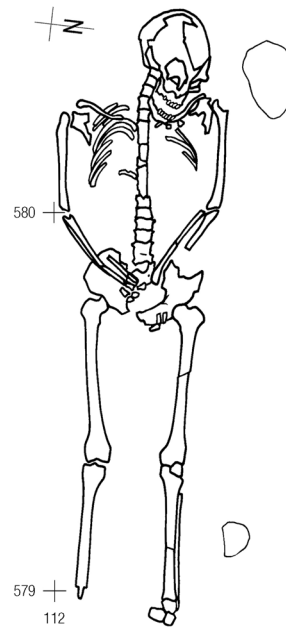

Grab 45

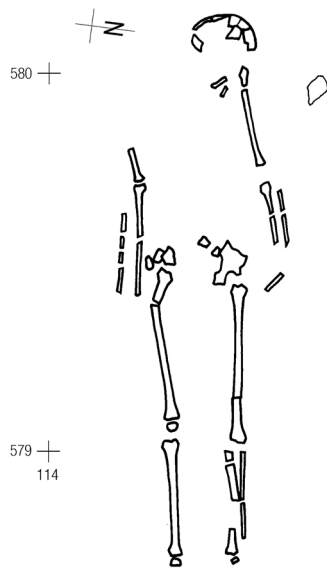

Grab 48

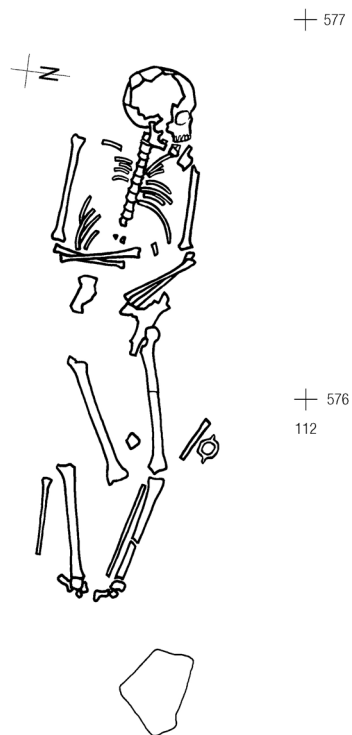

Grab 49

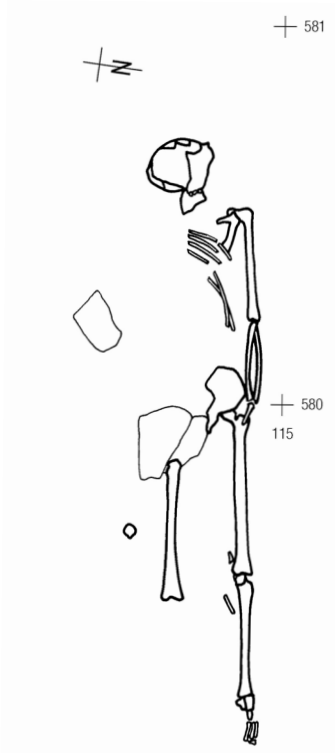

Gräber 52/53

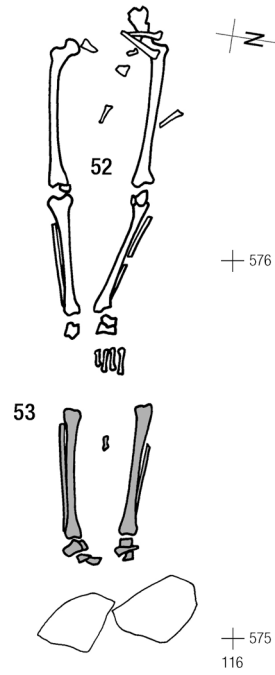

Gräber 57/61

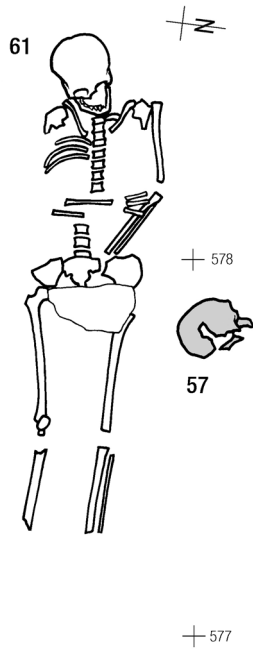

Grab 62

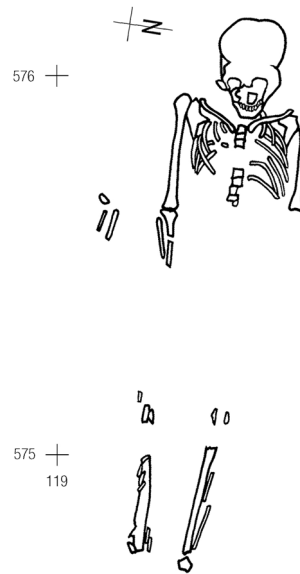

Gräber 63/65

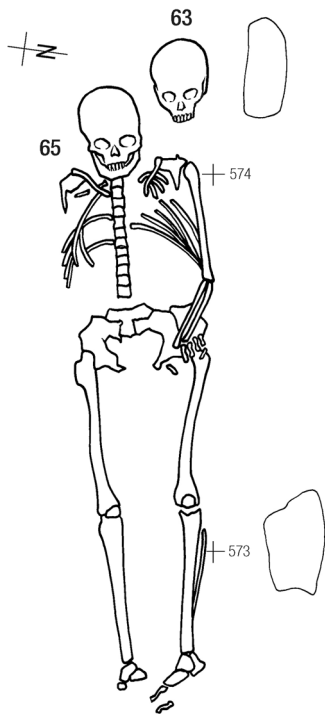

Grab 66

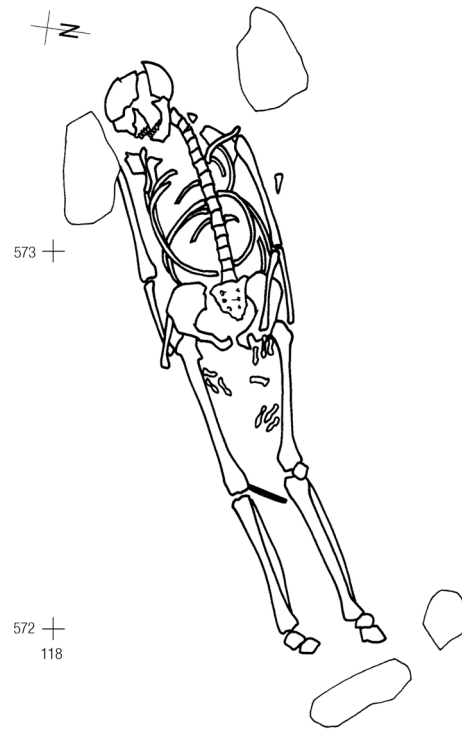

Gräber 64/68

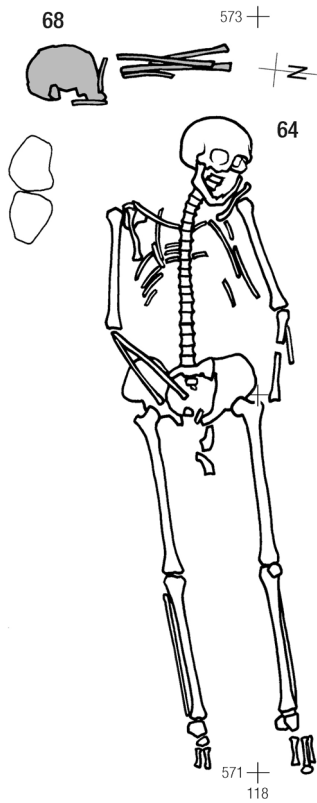

Gräber 67/76/77/81

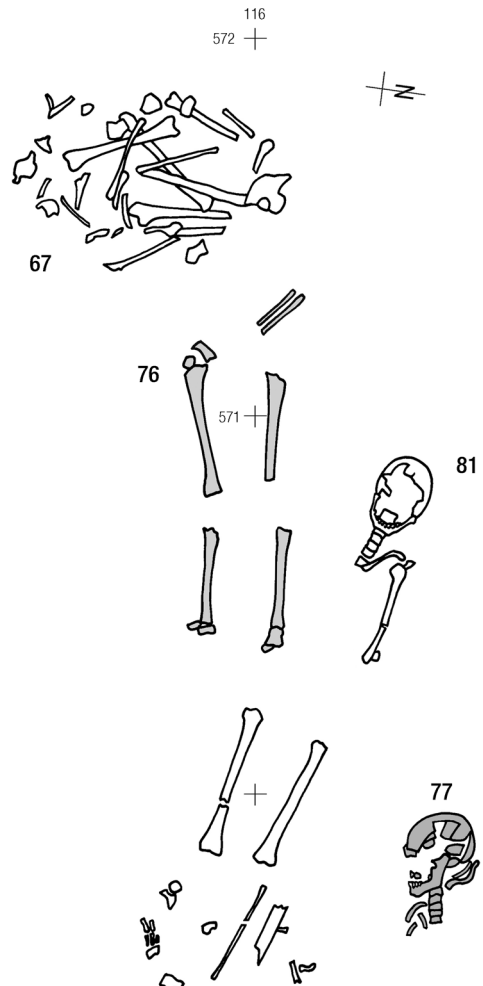

Grab 69

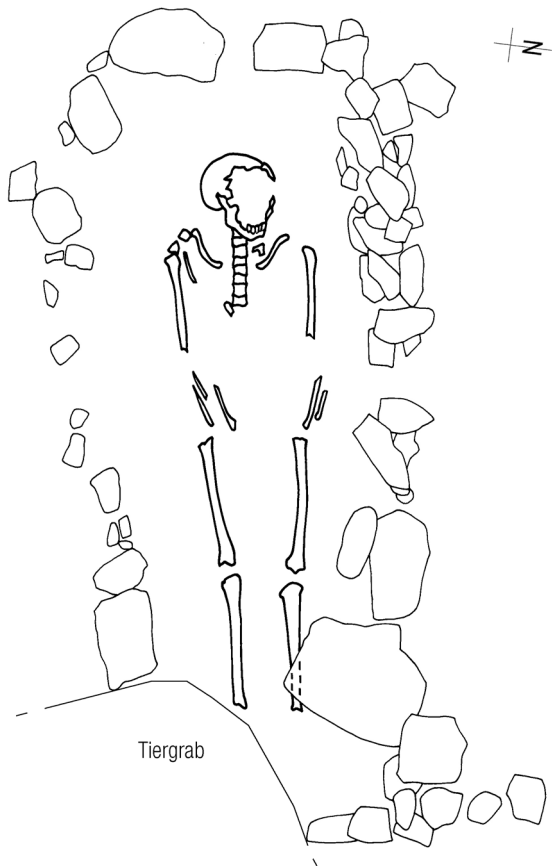

Grab 70

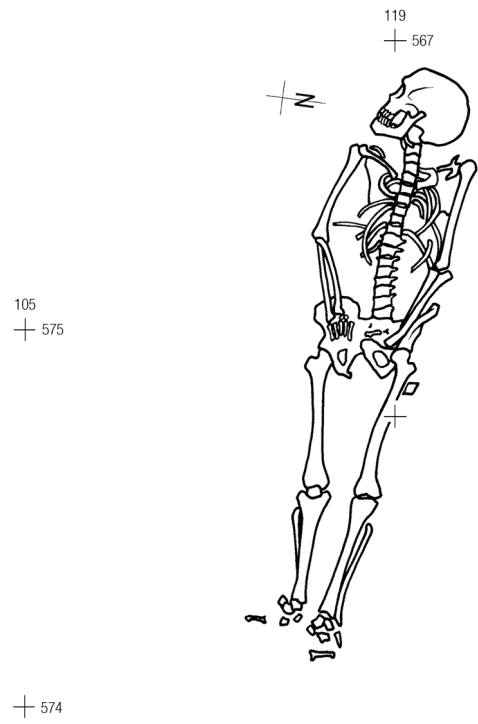

Gräber 71/72/75

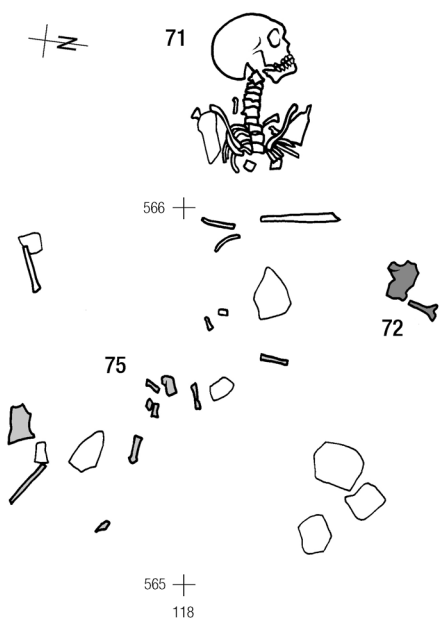

Gräber 73/74

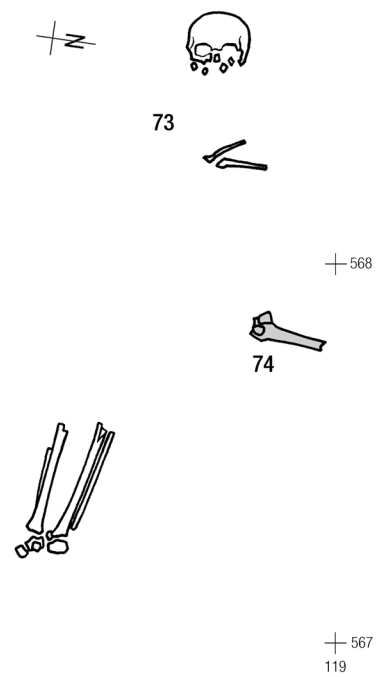



Grab 78

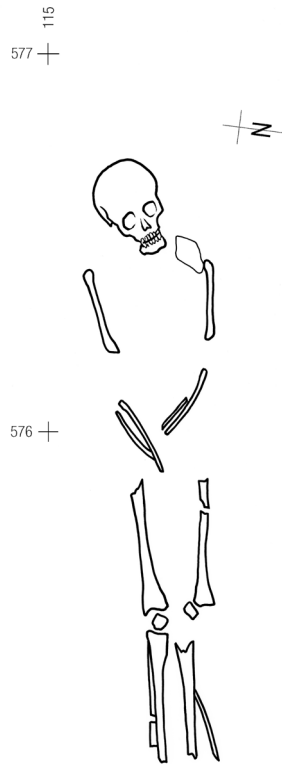

Grab 79

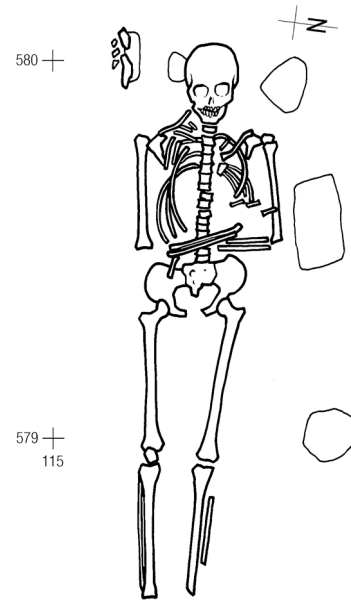

Gräber 80/83

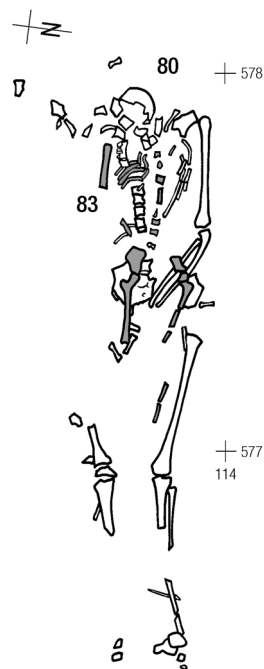

Gräber 82/85/86

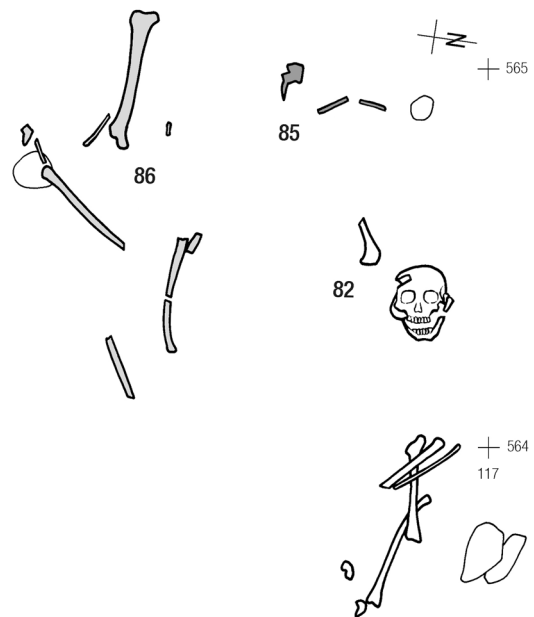

Grab 84

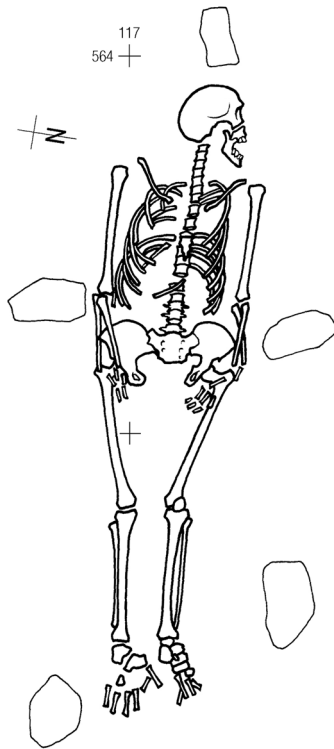

Gräber 90/91

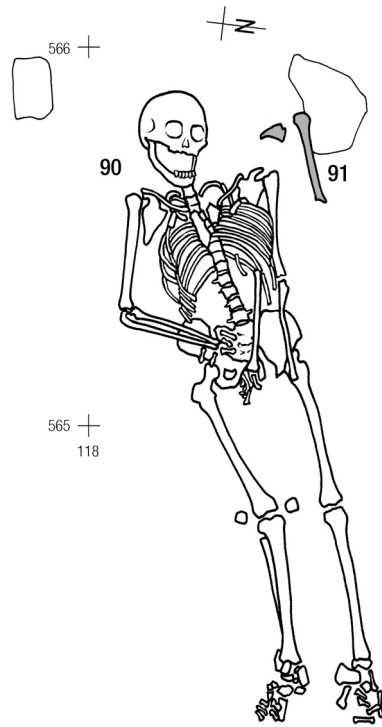

Grab 92

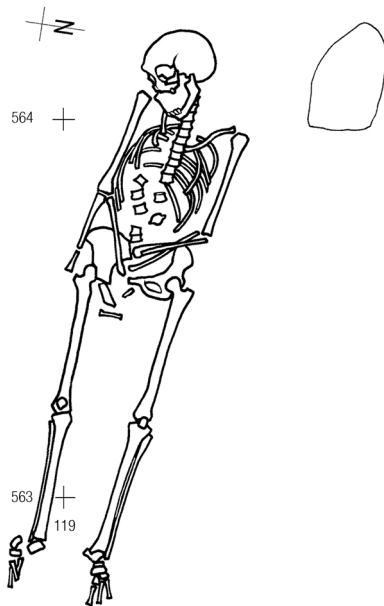

Gräber 93/97

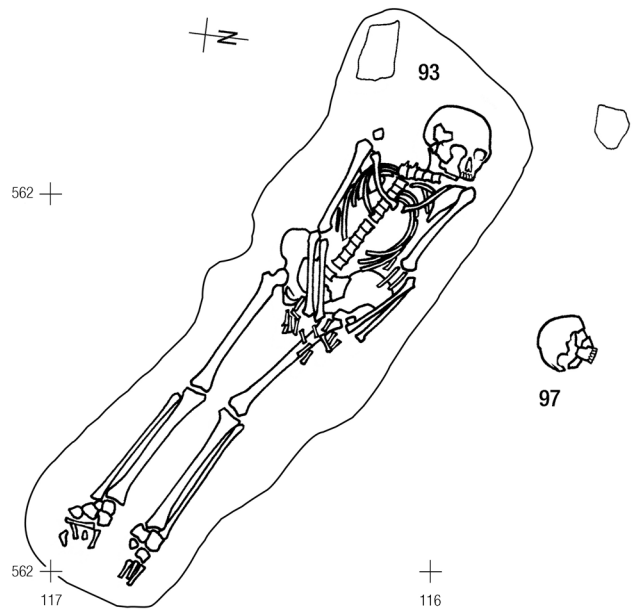

Grab 95

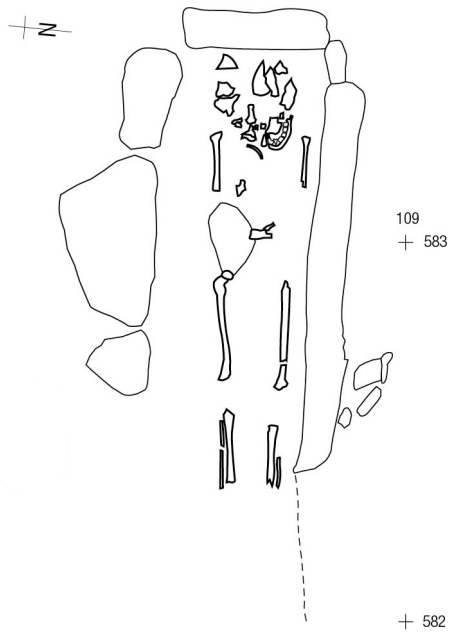

Gräber 99/100

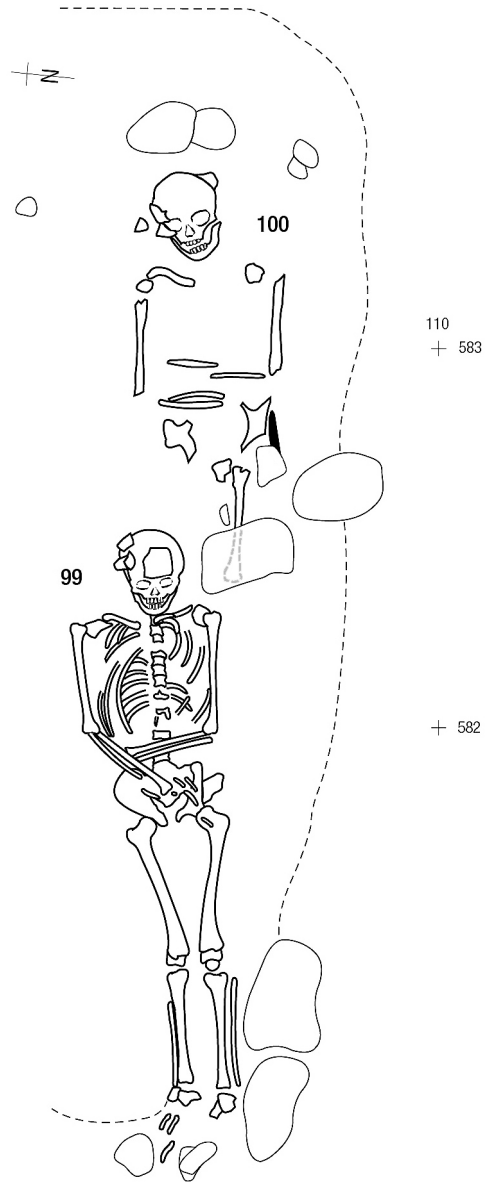

Gräber 103/105/132

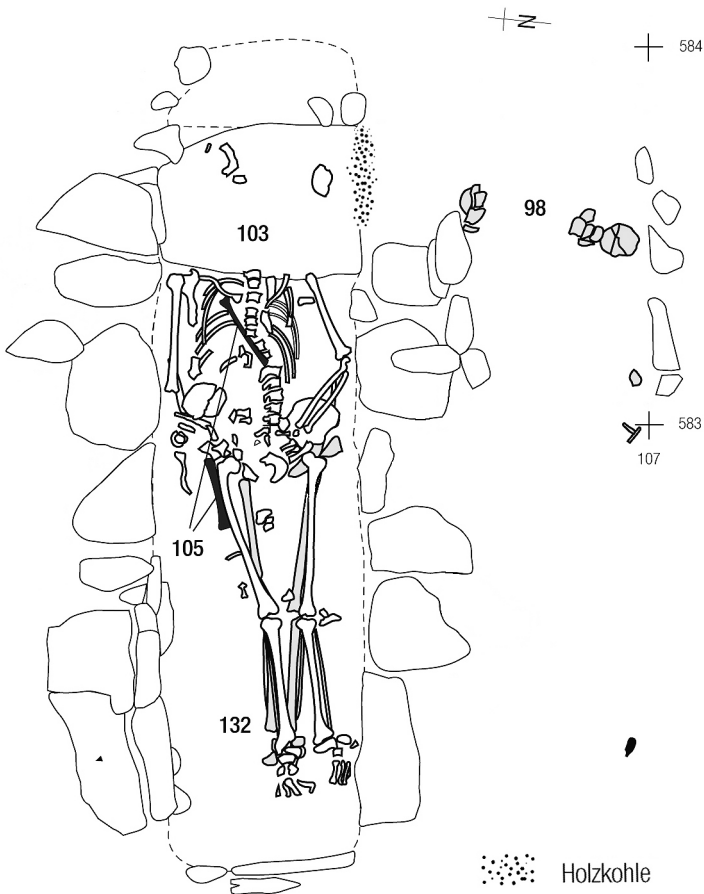

Grab 101

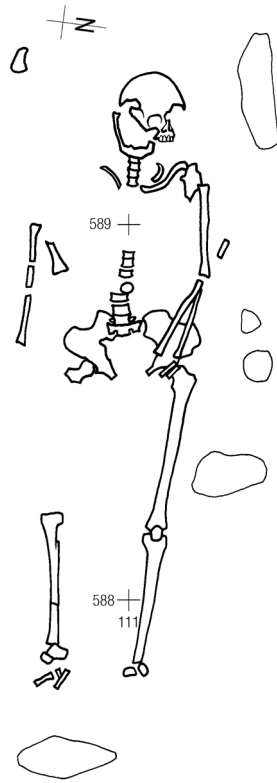

Grab 102

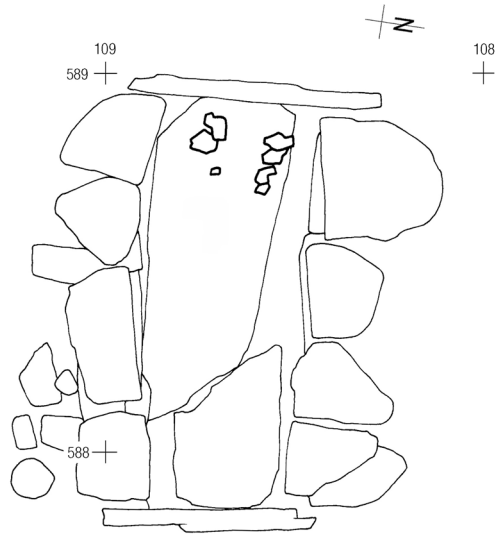

PROFIL TOMBE 102  
GOSUS 19.12.39  
SECT. 63C  
FRANCO SOLJANI

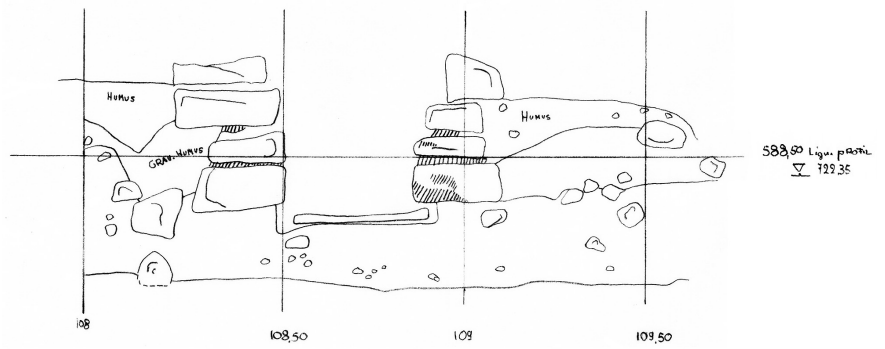

Grab 102, Profil (Grabungszeichnung)

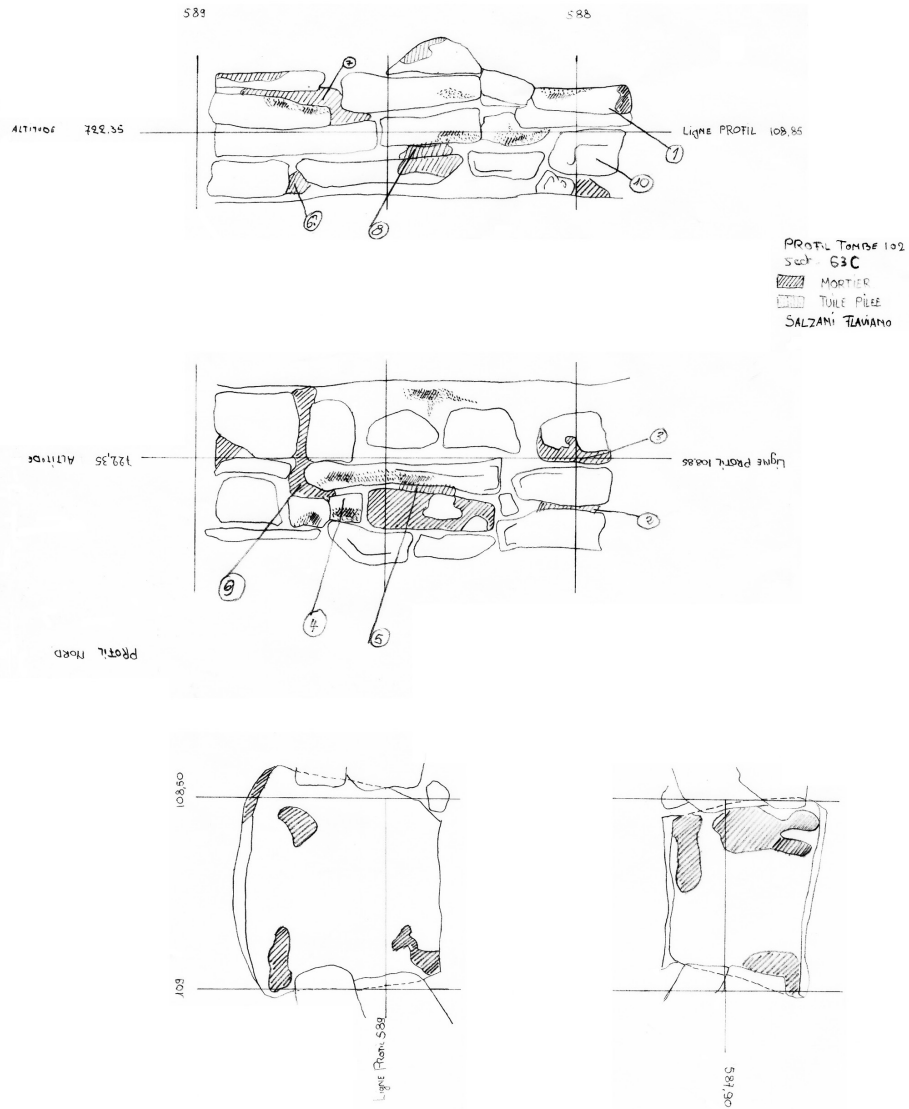

Grab 102, Aufrisse (Grabungszeichnung)

Gräber 107/158

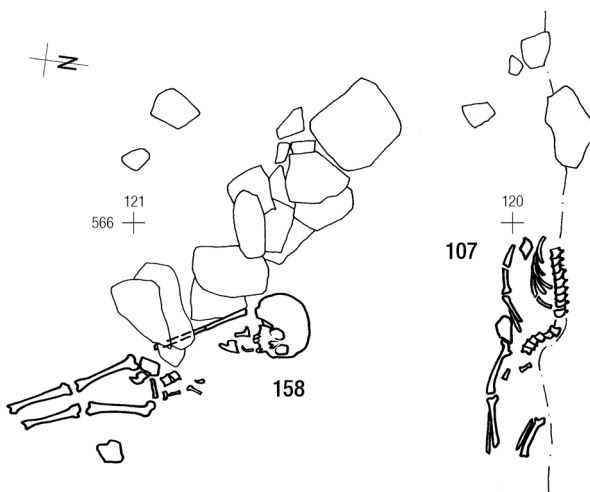

Grab 108

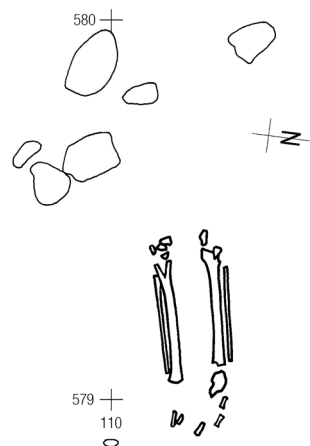

Grab 109

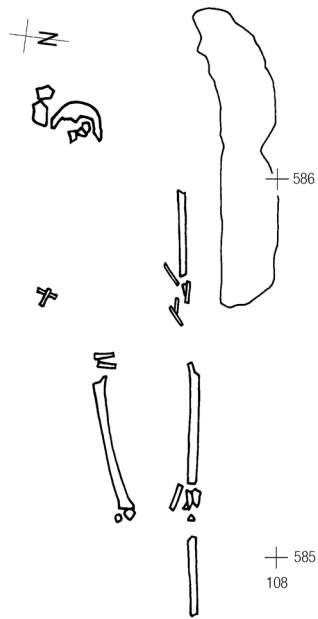

Gräber 110/117

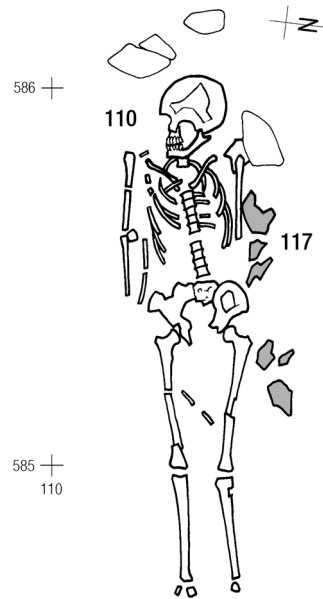

Grab 111

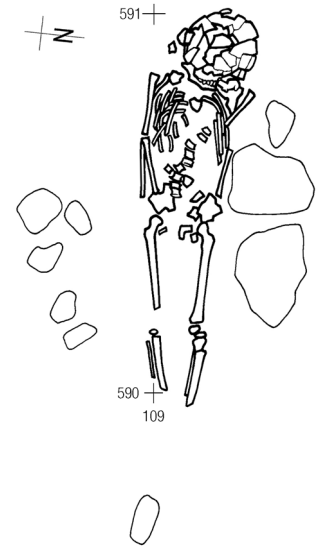

Gräber 112/46

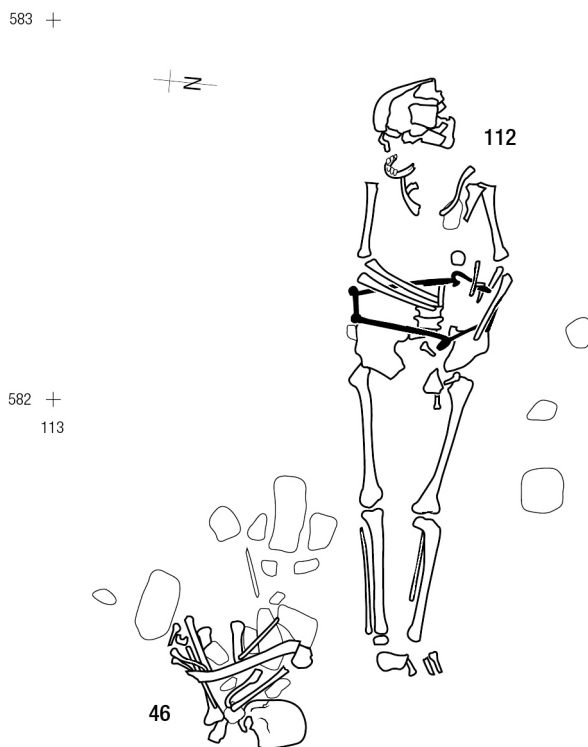

Grab 113

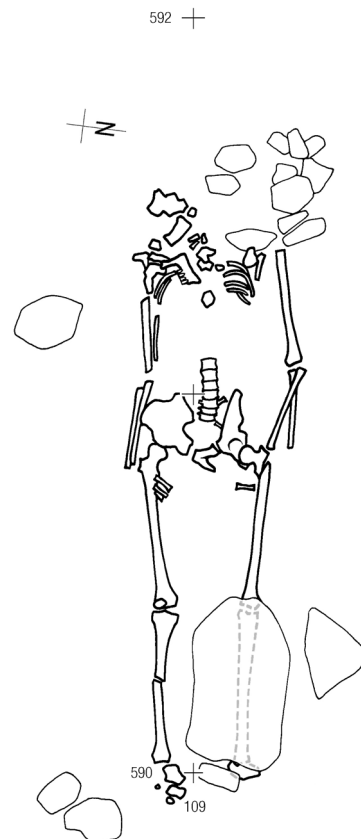

Grab 114

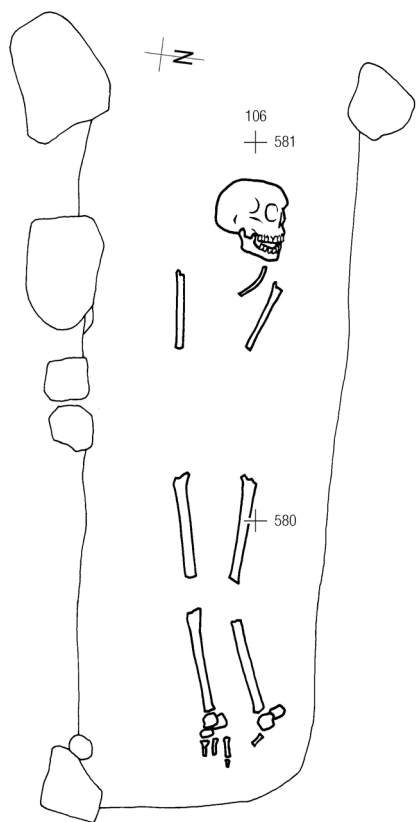

Gräber 115/116

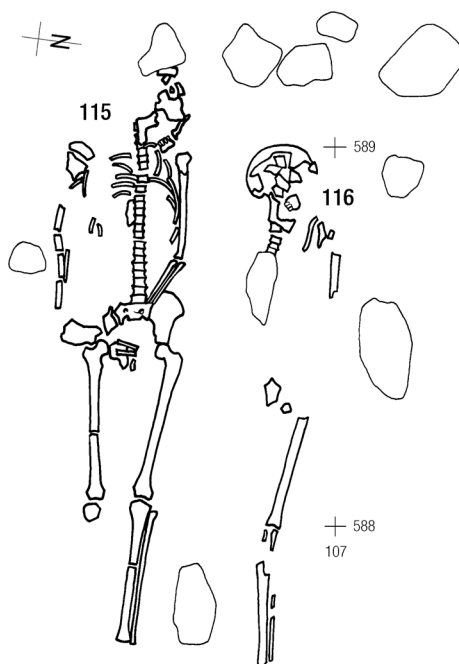

Gräber 119/120/124

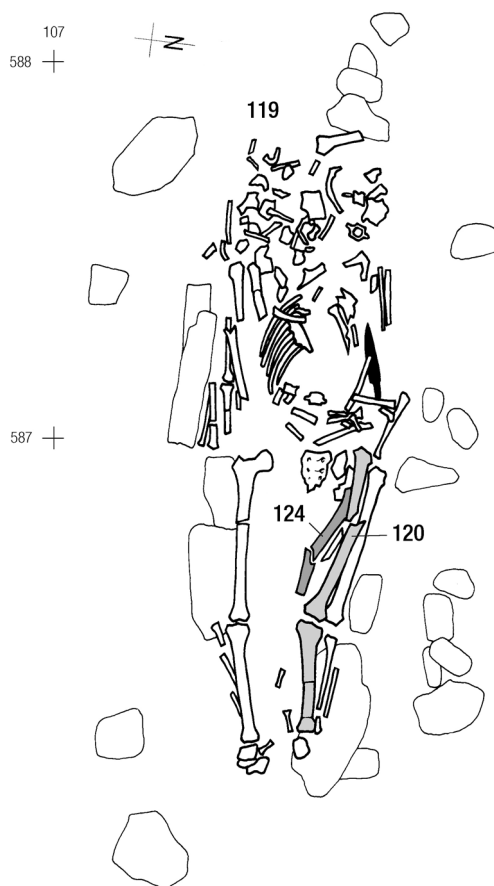

Grab 118



Grab 121

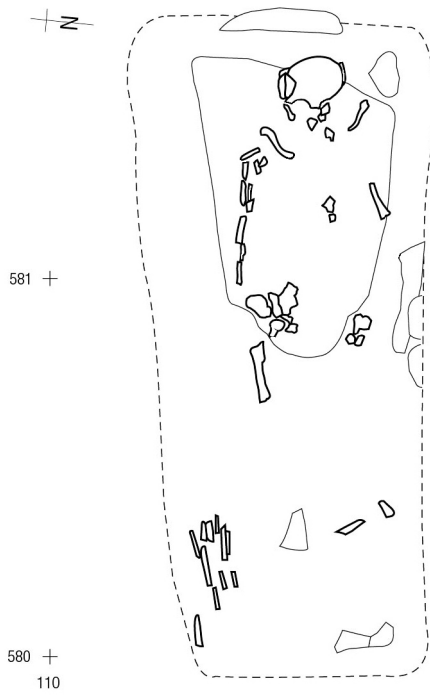

Grab 122

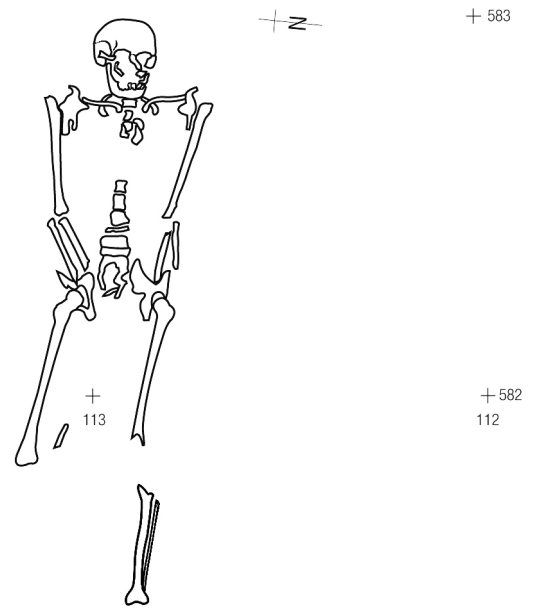

Gräber 123/126/128

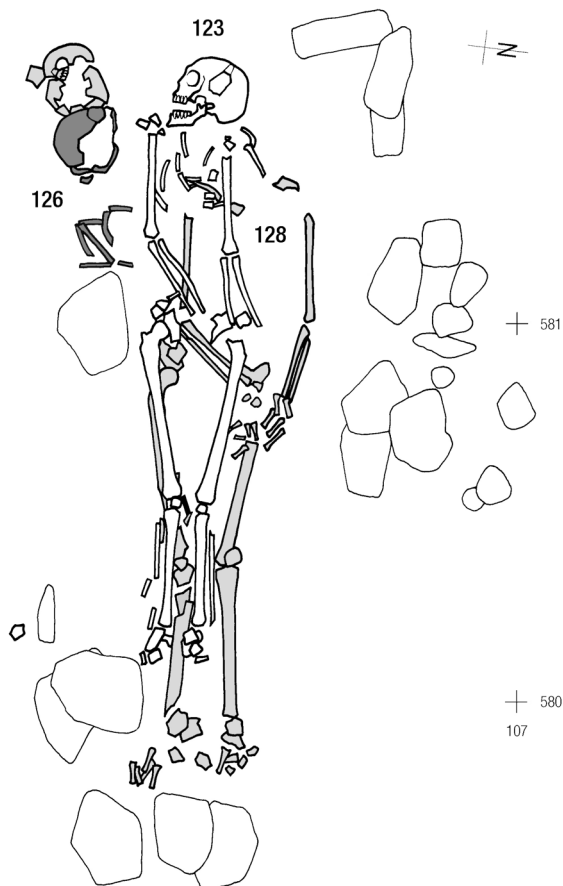

Grab 125

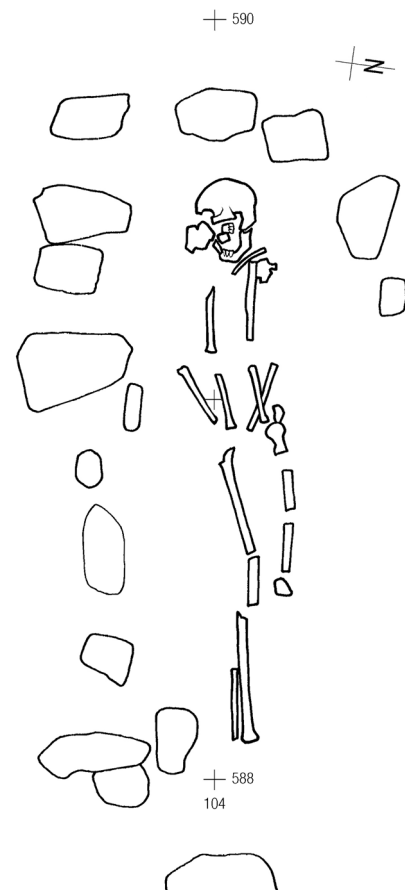



Grab 127

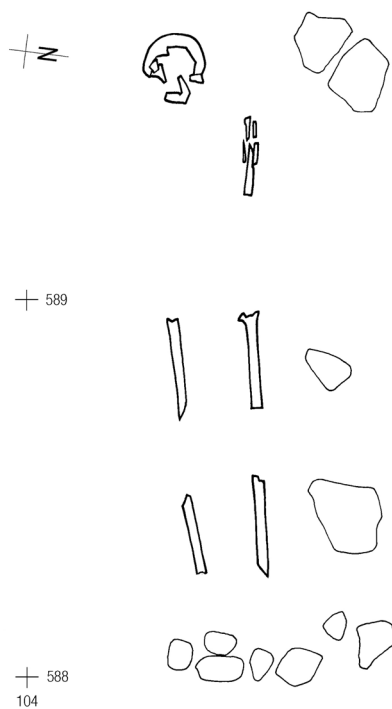

Gräber 130/133/134/136/137

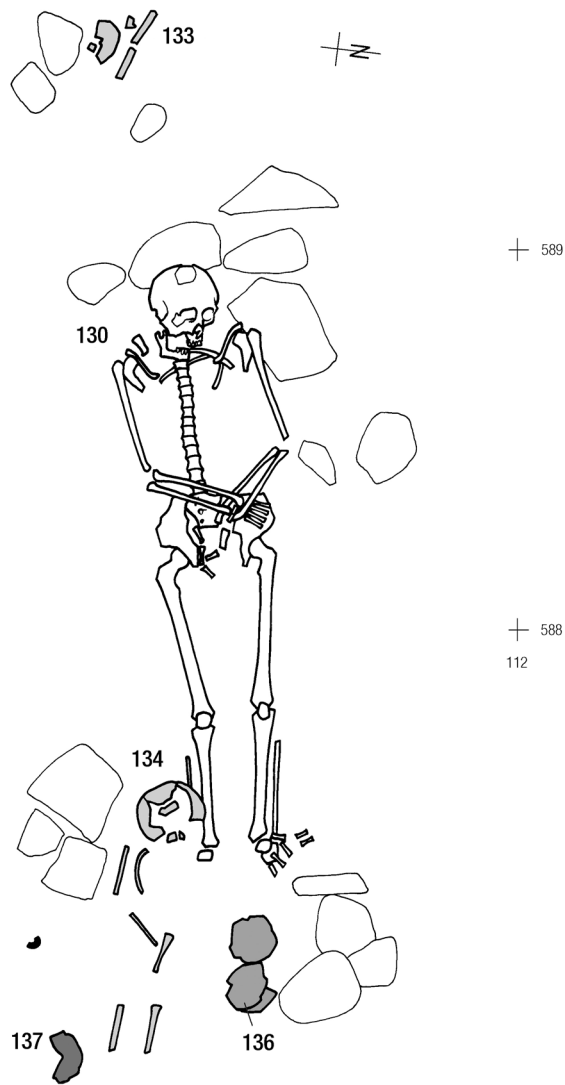

Grab 129

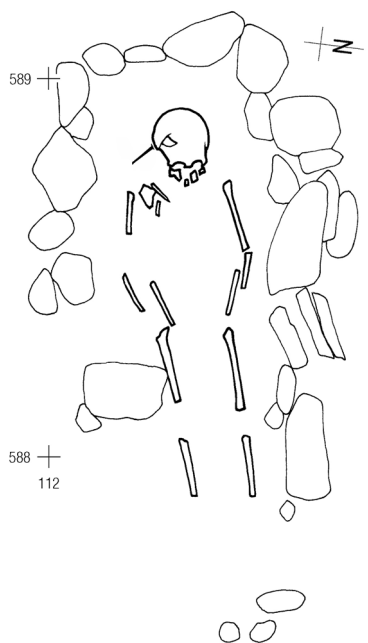

Grab 131



Grab 135



Grab 138

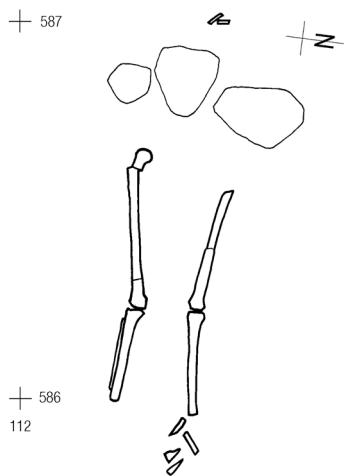

Grab 139

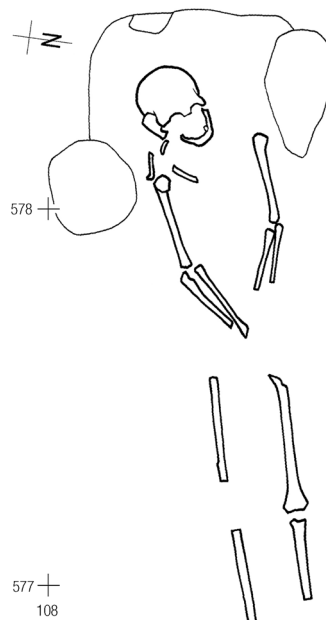

siehe auch Gräber 38/59/60/139

Grab 140

60-505 79  
Section 33A/C  
Tombe n° 140 (A)  
Sud-Algerien.

N 128.

mesures à ajouter à 721  
b = base

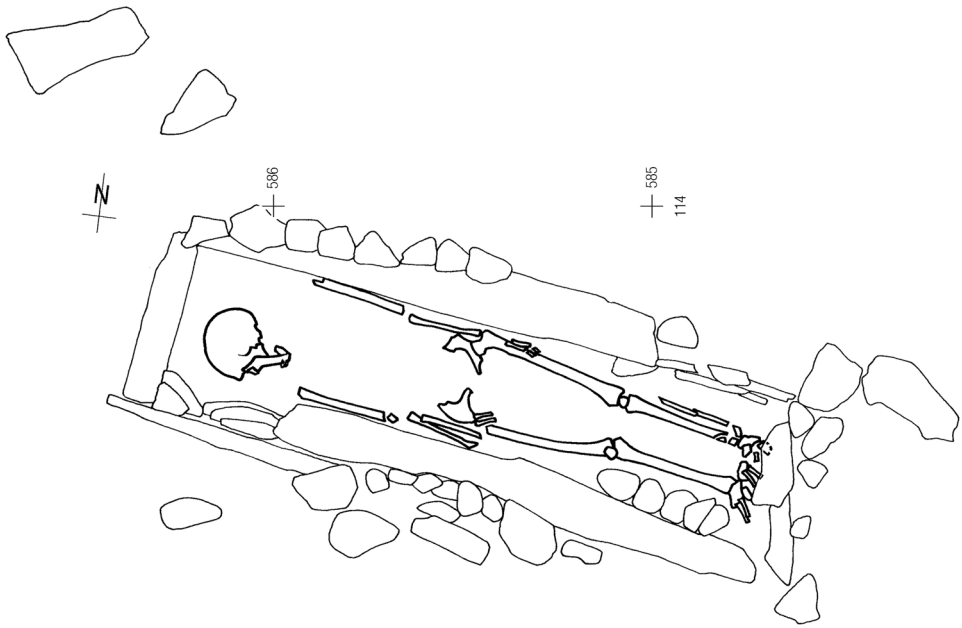
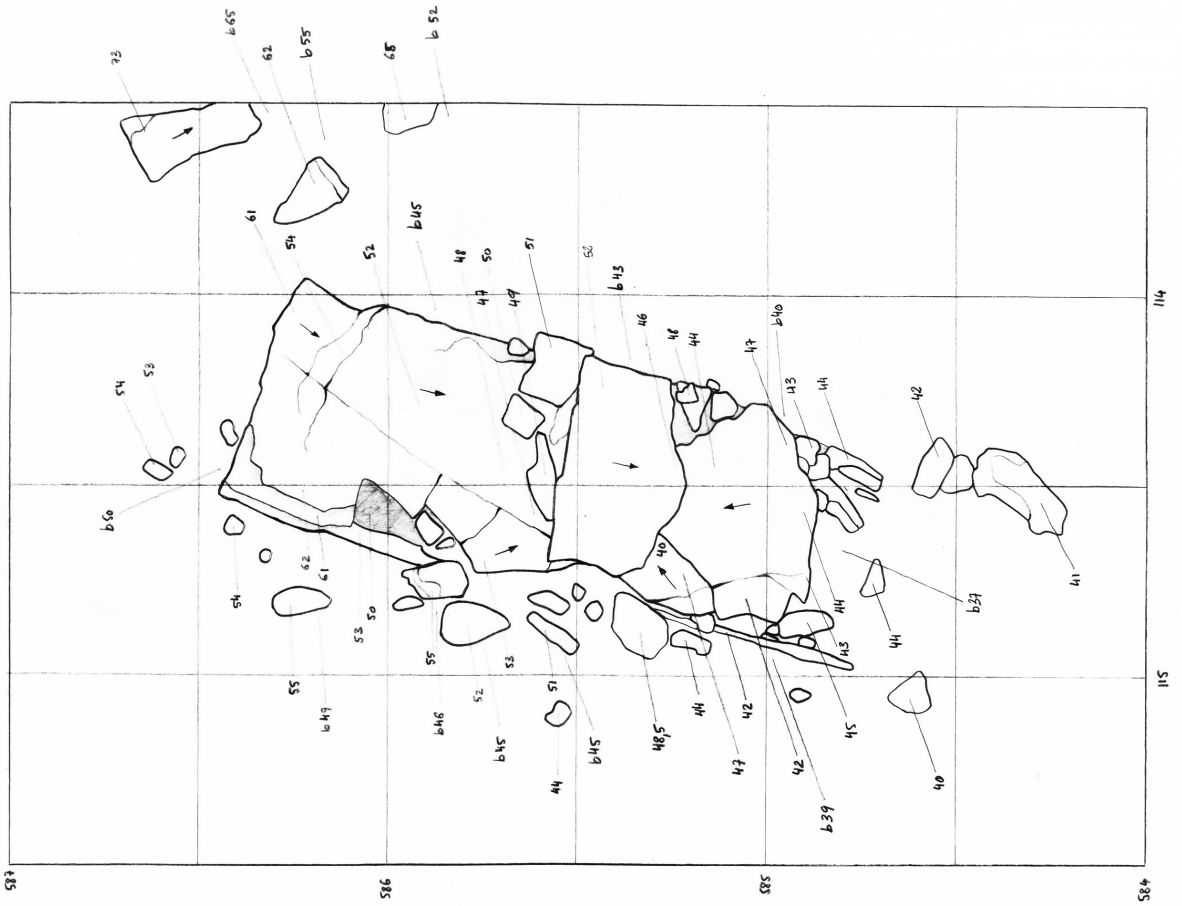

Grab 140, Steinabdeckung (Grabungszeichnung)



Grab 141

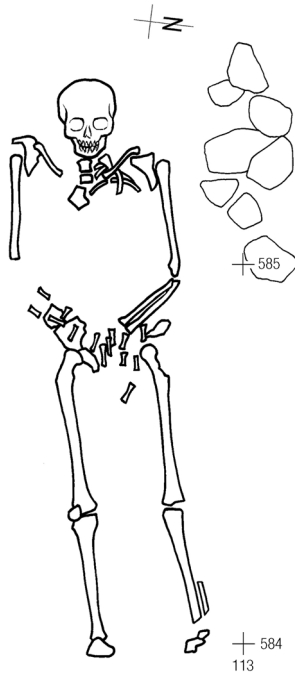

Grab 143

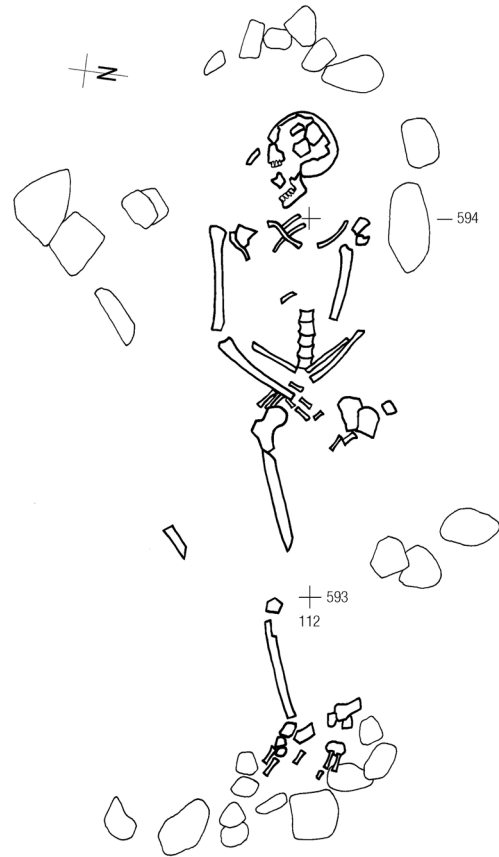

Grab 142

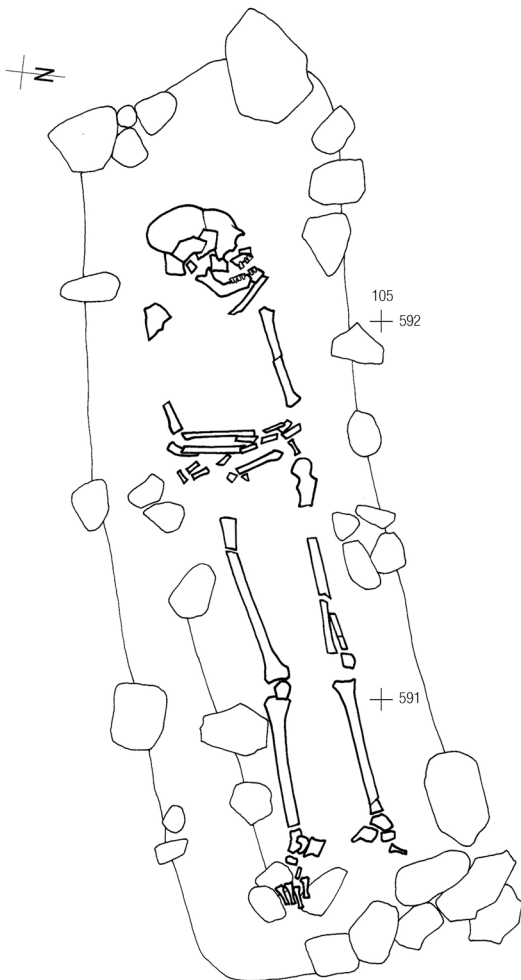

Gräber 144/157

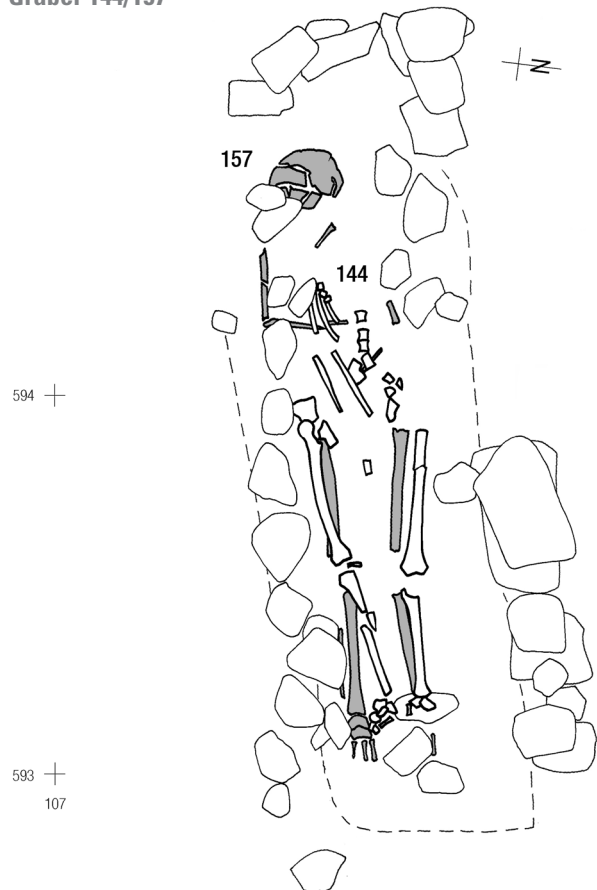

Gräber 145/228

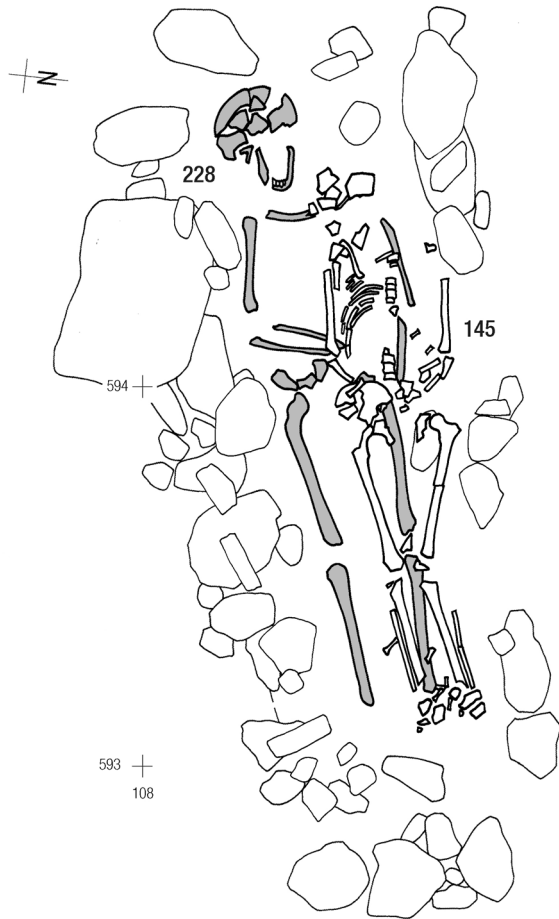

Gräber 146/147

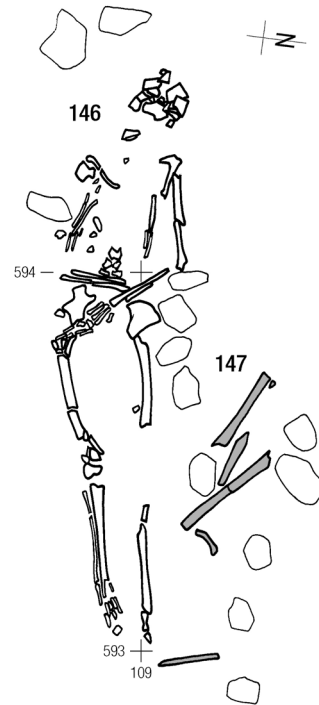

Grab 148

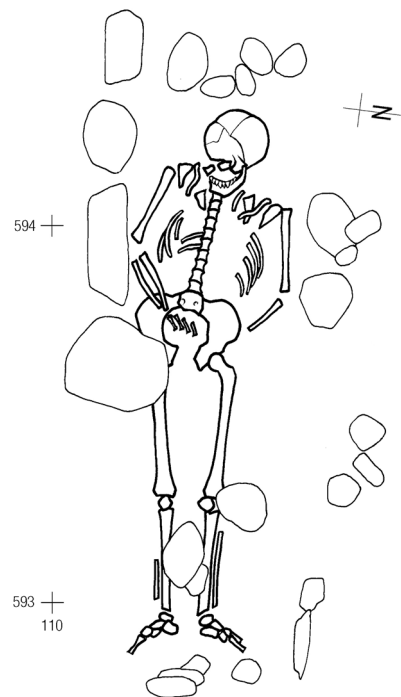

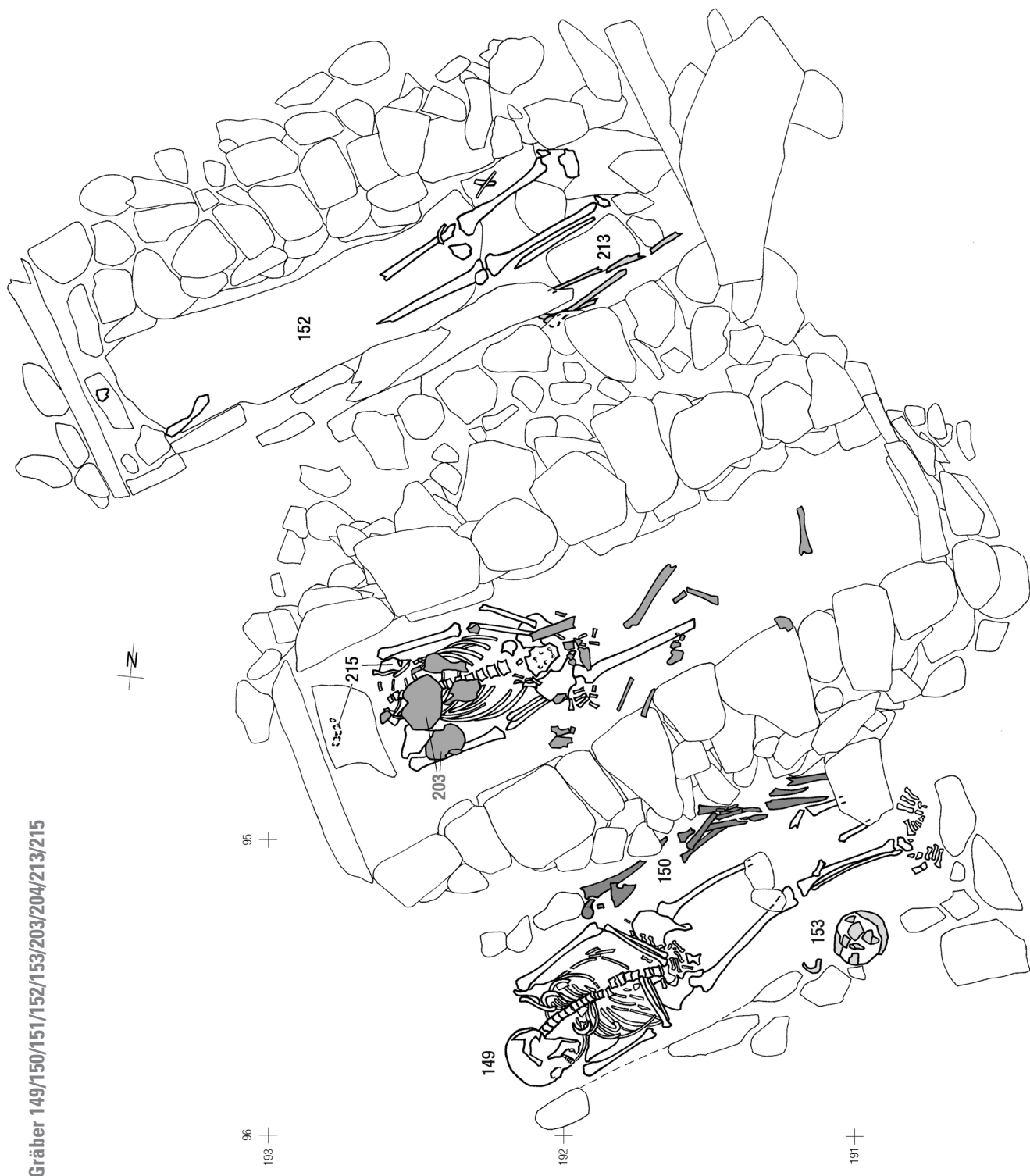

Gräber 149/150/151/152/153/203/204/213/215

Grab 154

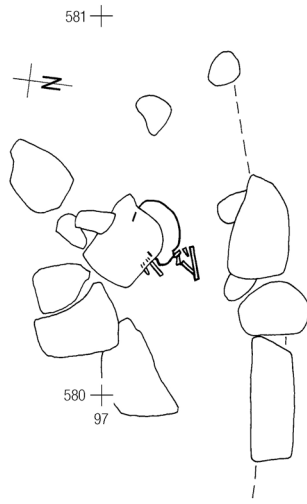

Grab 155



Grab 156

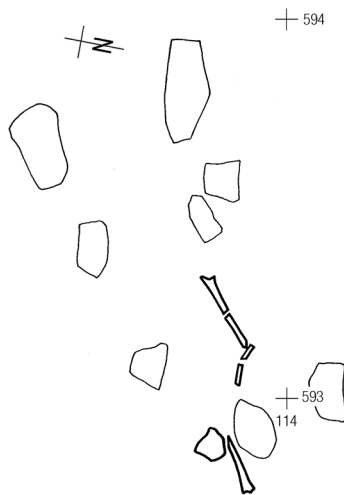

Gräber 159/160/161

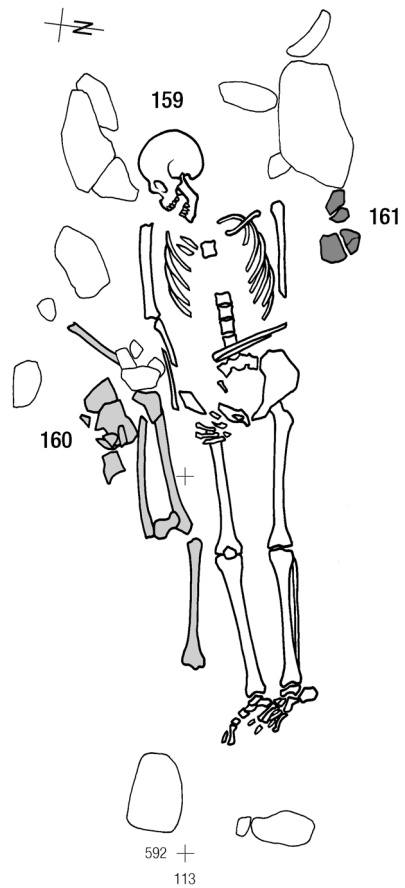



Gräber 162/163/164/165/166

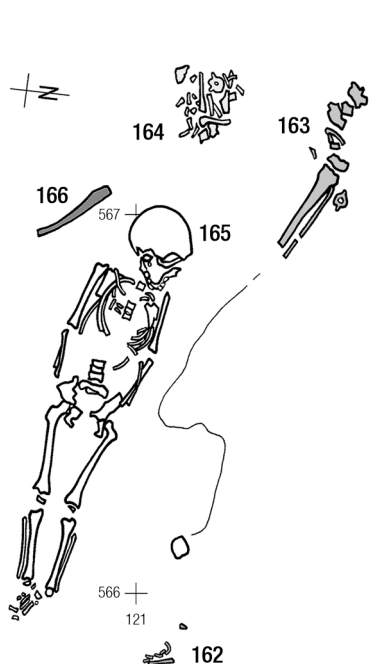

Grab 167

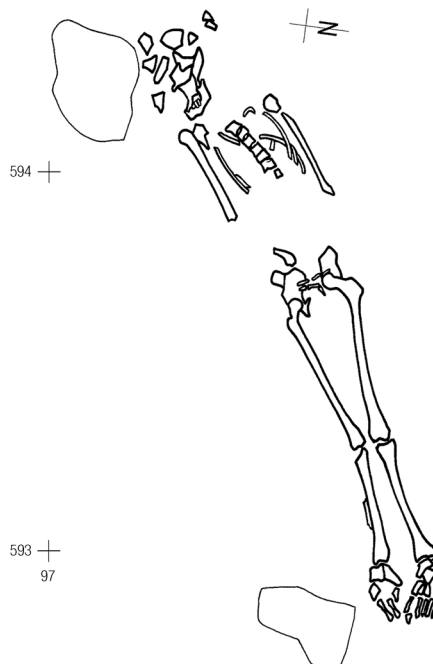

Gräber 168/188

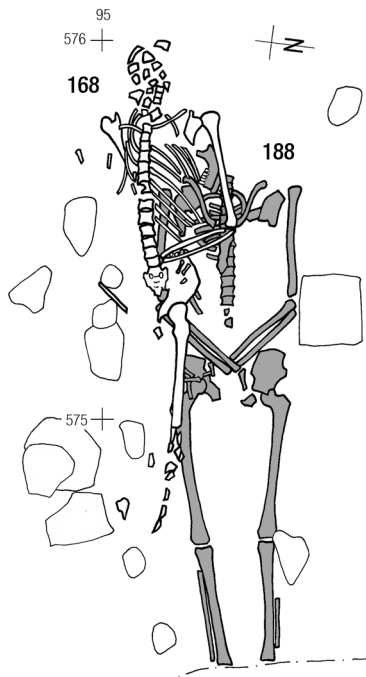

Gräber 169/175/187

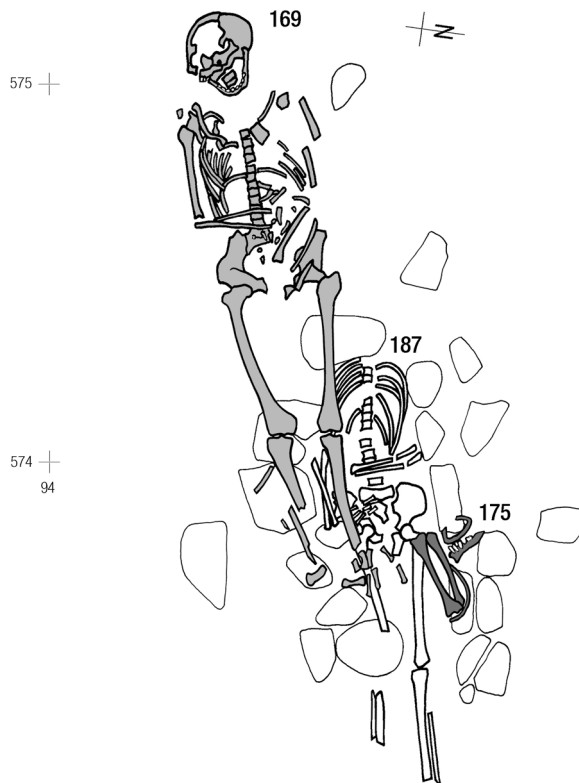

Grab 170

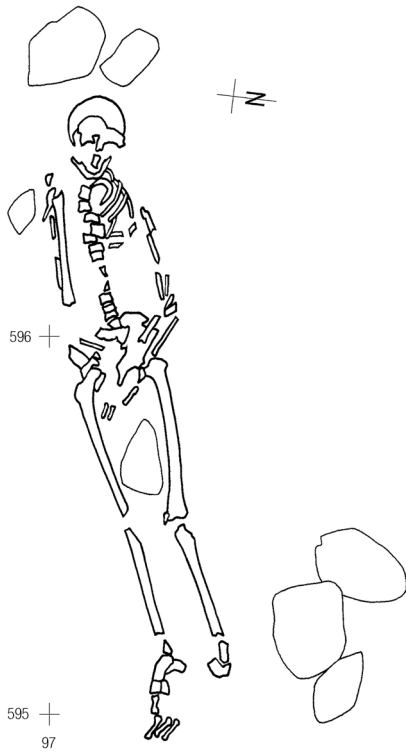

Grab 171

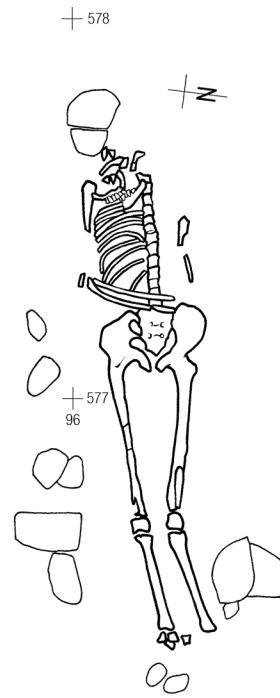

Grab 172

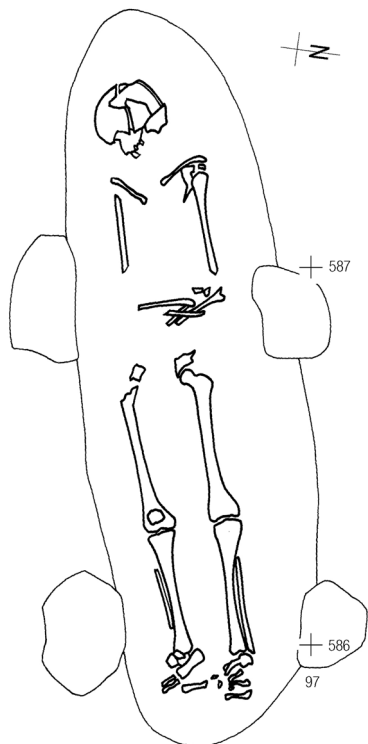

Grab 173

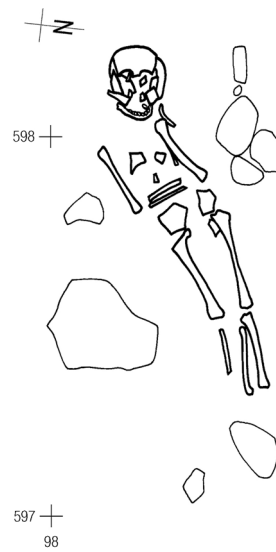

Grab 174

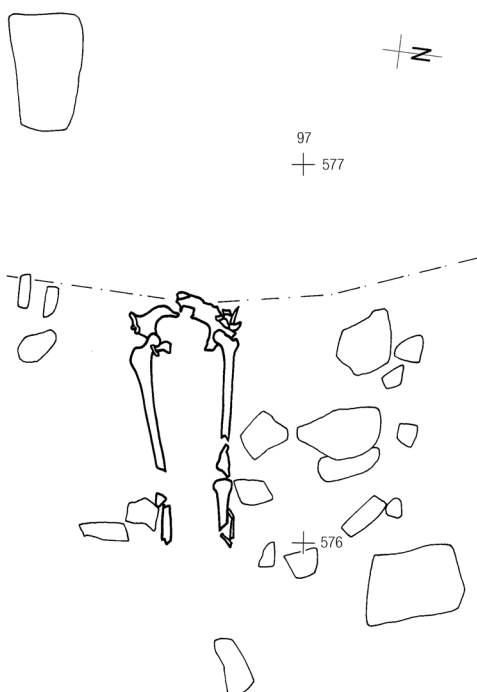

Gräber 177/181

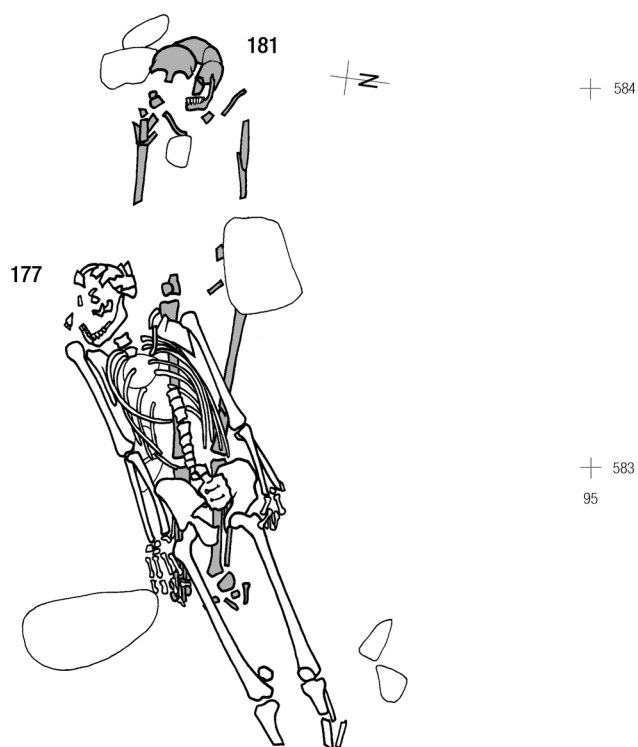

Grab 178

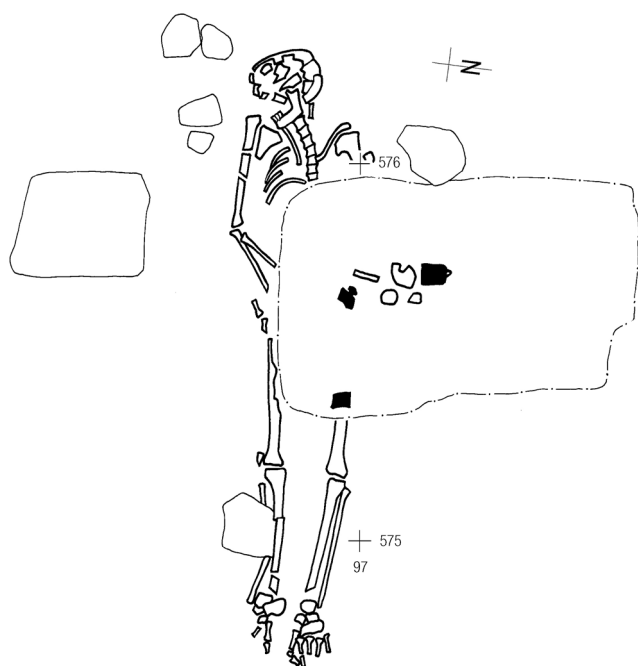

Grab 179

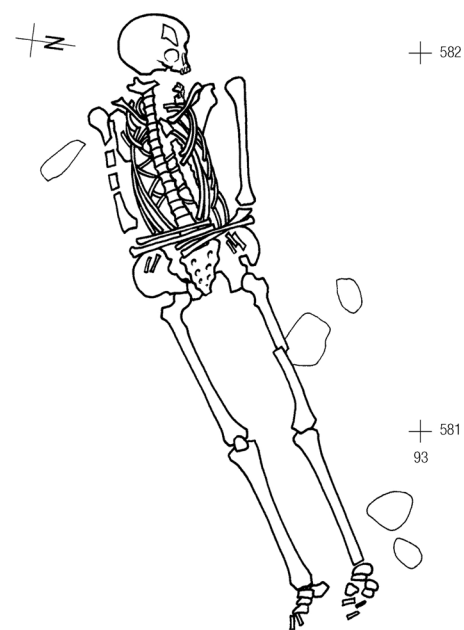

Grab 180

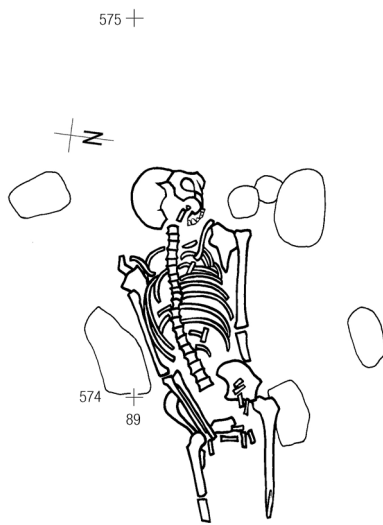

Grab 182

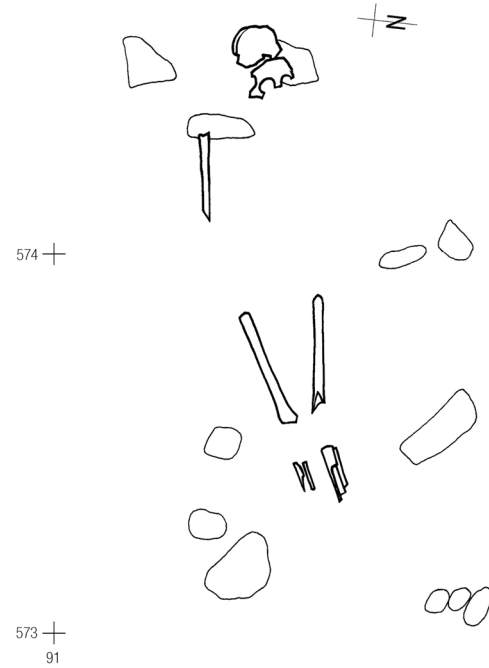

Grab 183

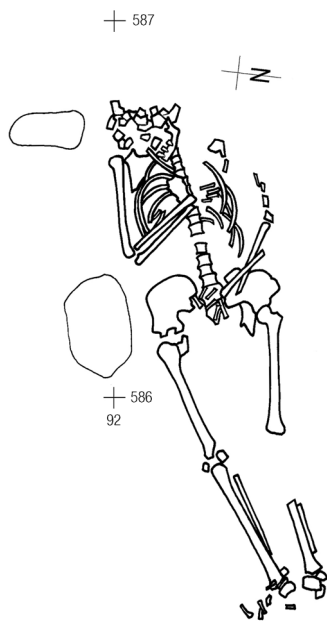

Grab 184



Grab 185

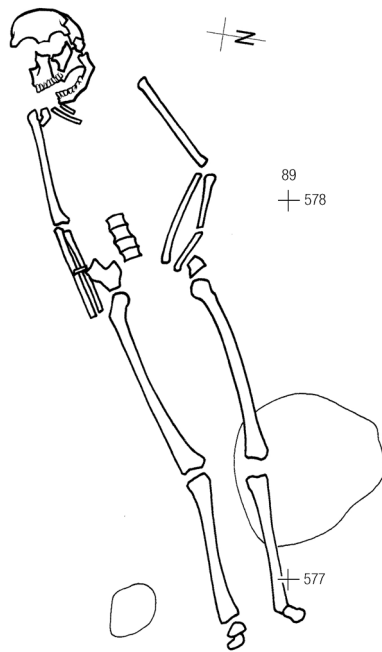

Grab 186

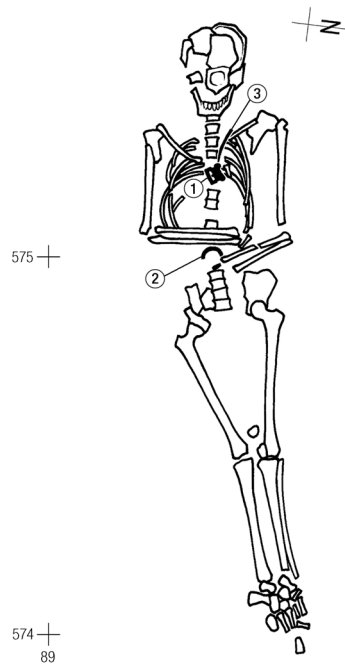

Grab 189

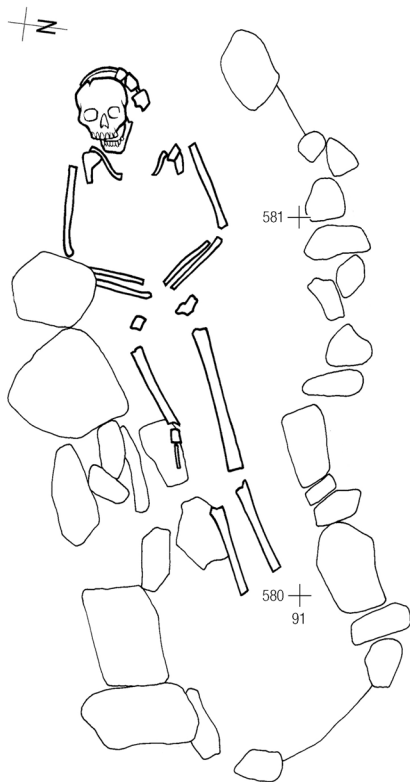

Grab 190



Grab 191

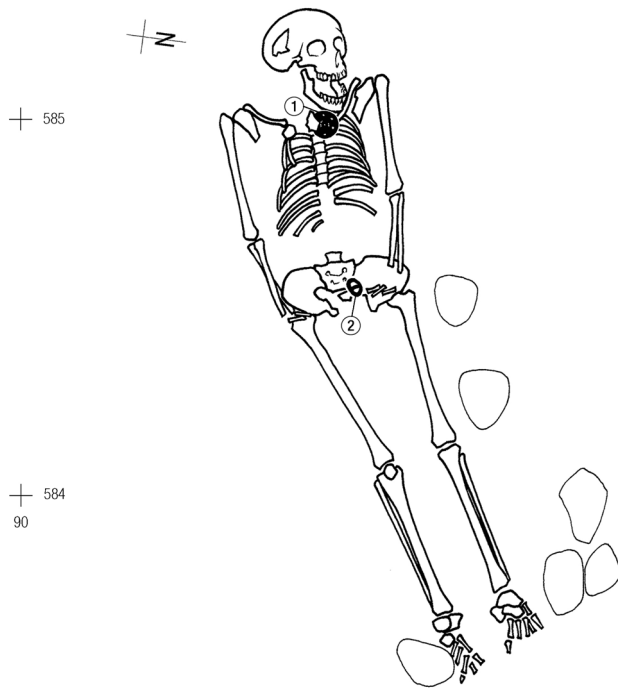

Grab 192

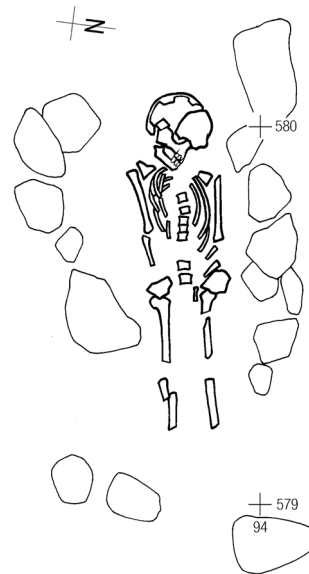

Grab 193

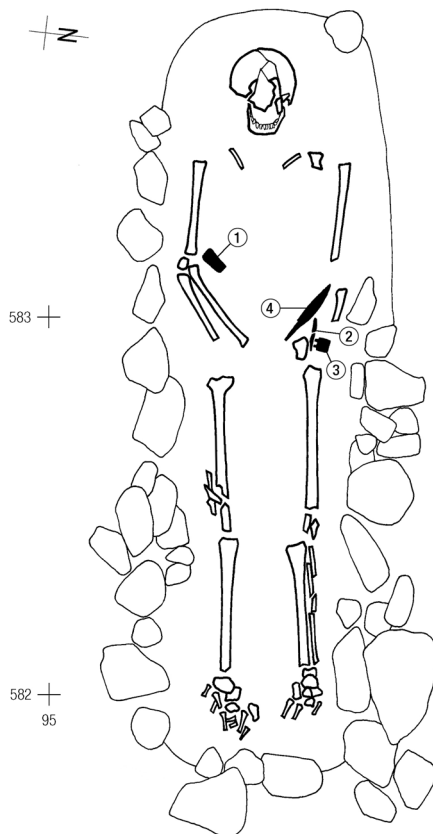

Gräber 194/197

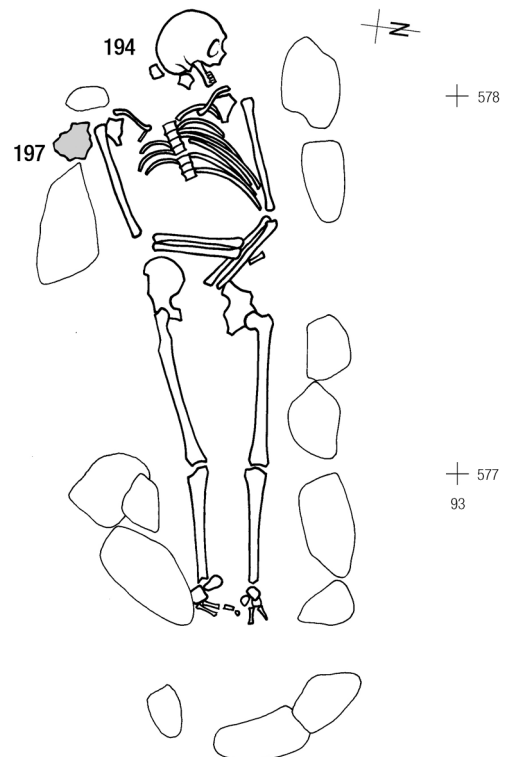

Grab 195

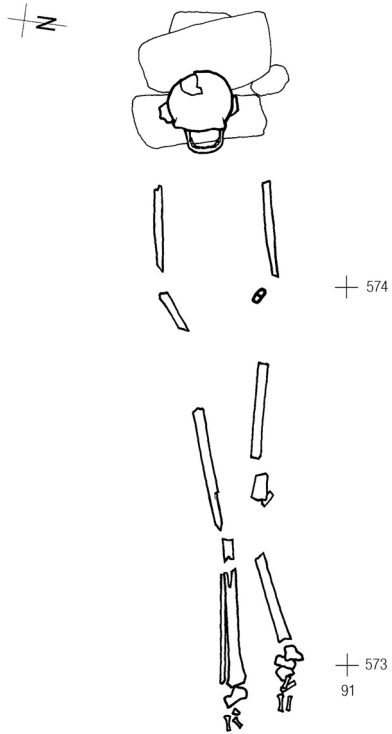

Grab 196

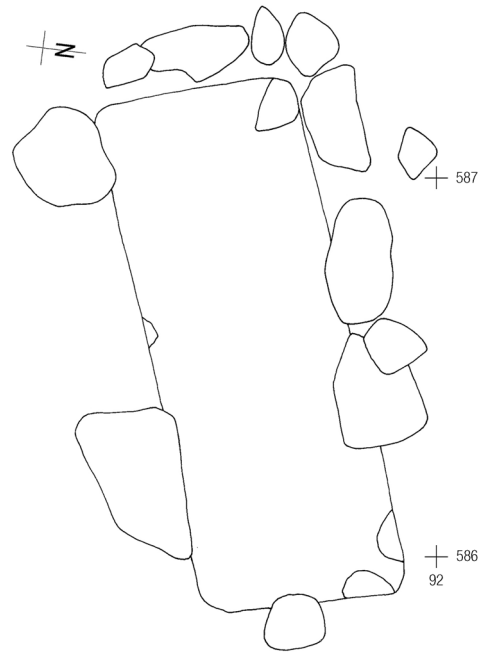

Grab 198

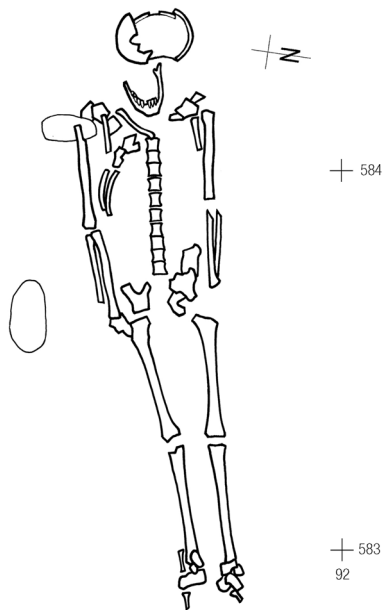

Grab 199

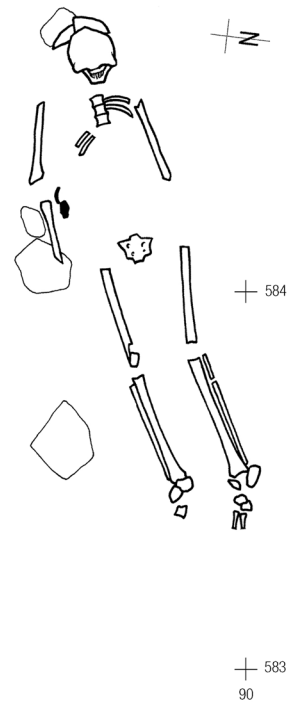

Grab 200

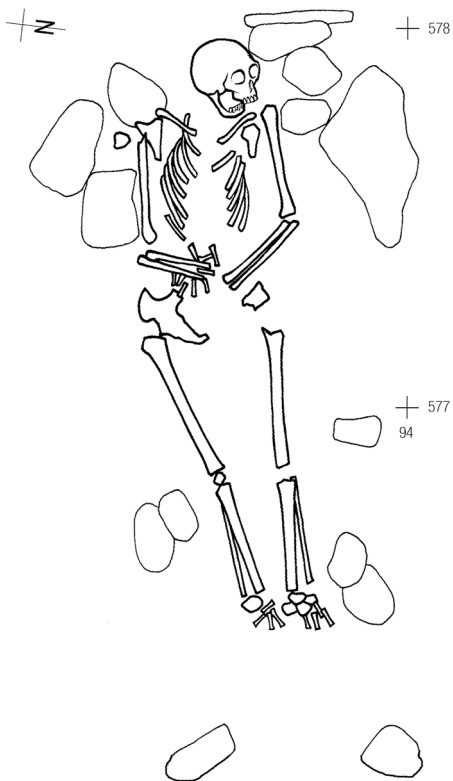

Gräber 201/214

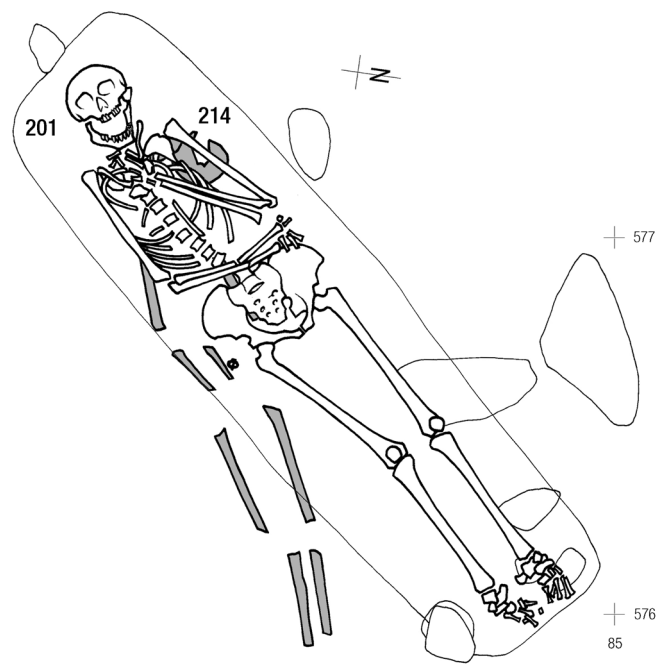

Gräber 202/209

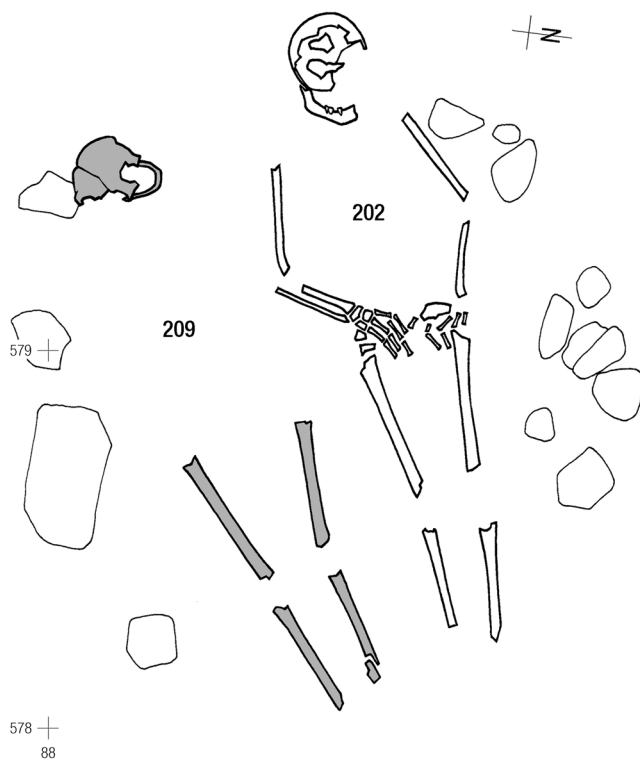

Grab 206

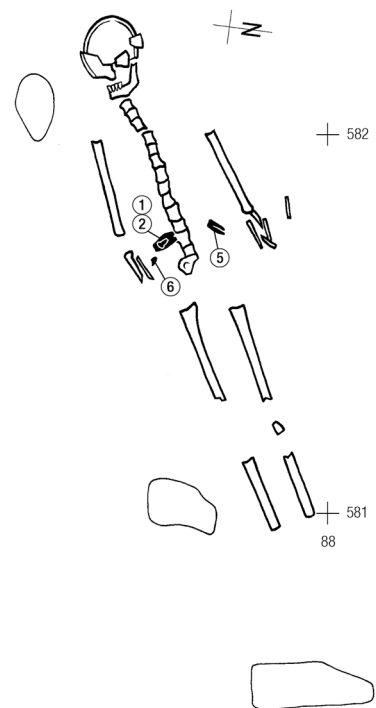



Grab 207

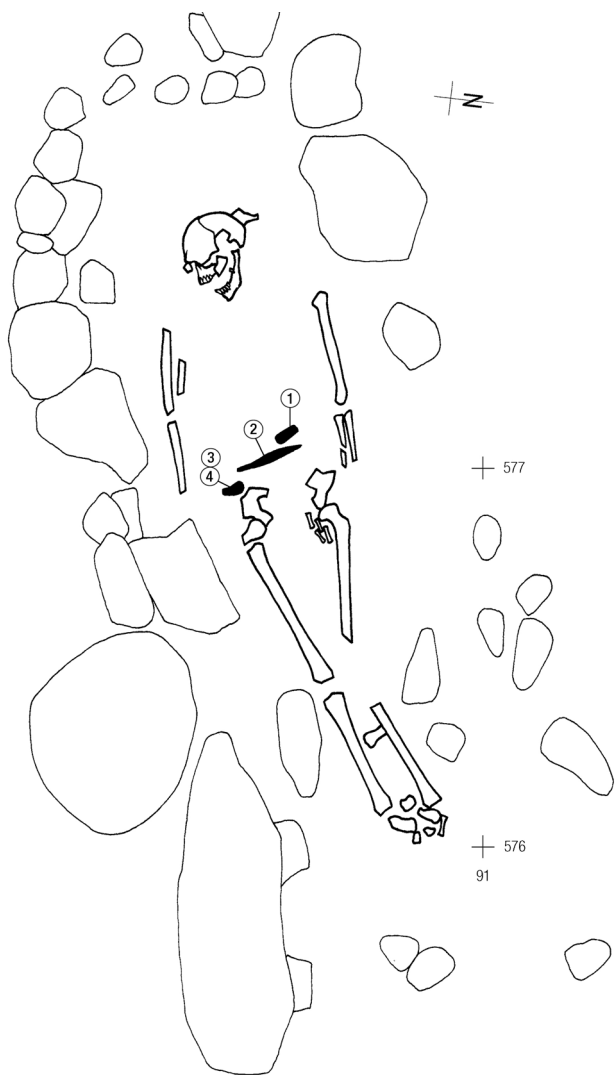

Grab 210

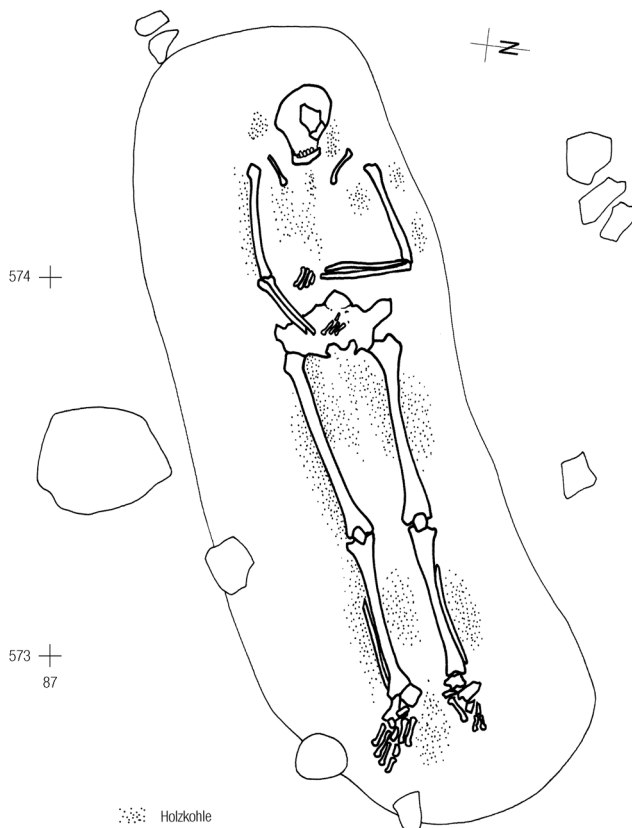

Grab 208

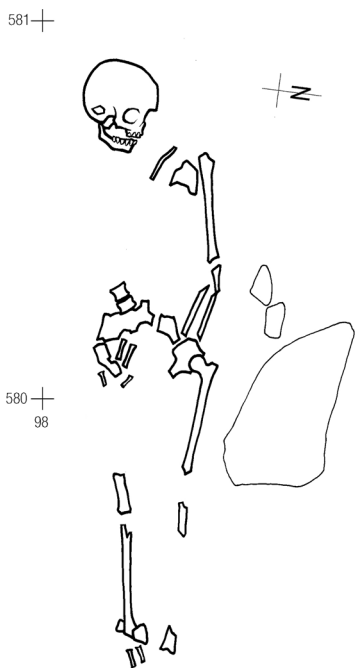

Grab 211

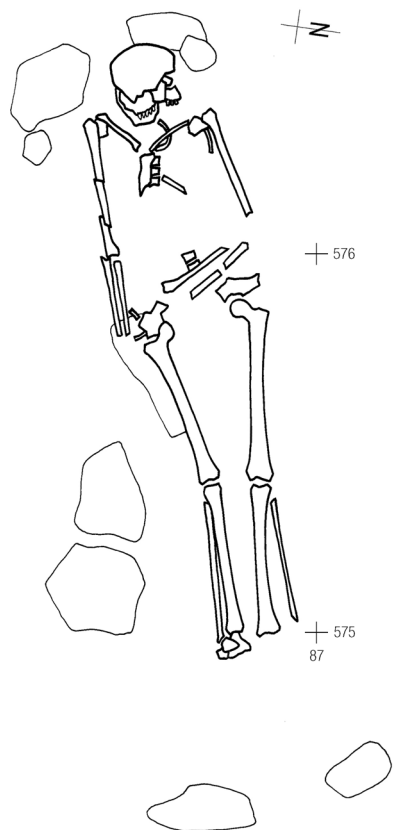

Grab 212

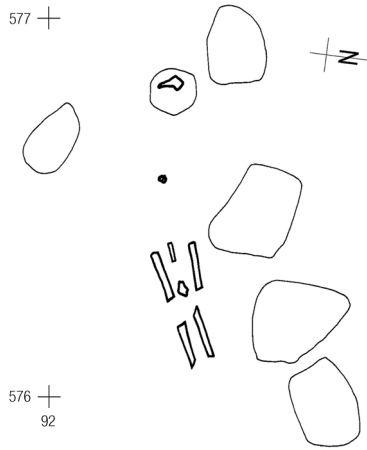

Grab 215

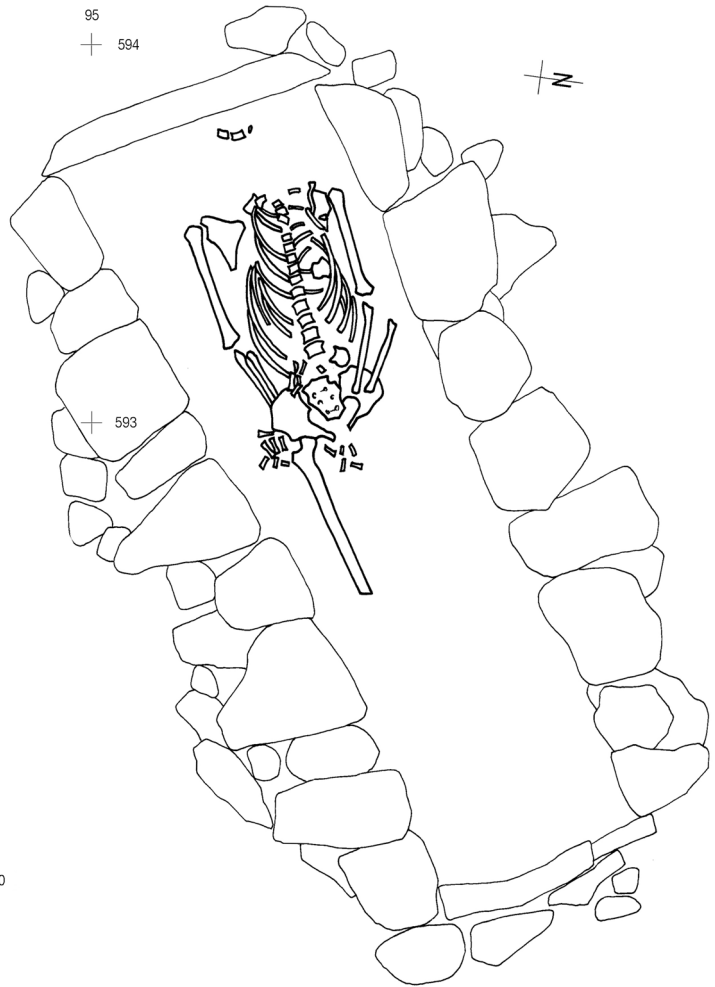

Gräber 216/219/220

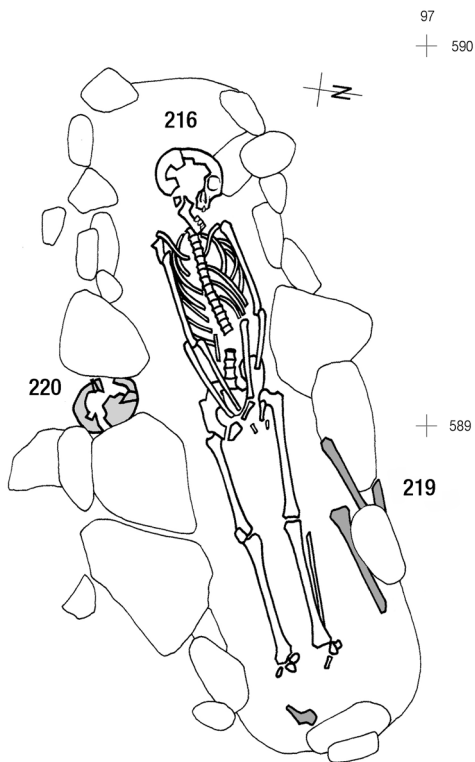

siehe auch Gräber 149/150/151/152/153/203/213/215

Grab 217

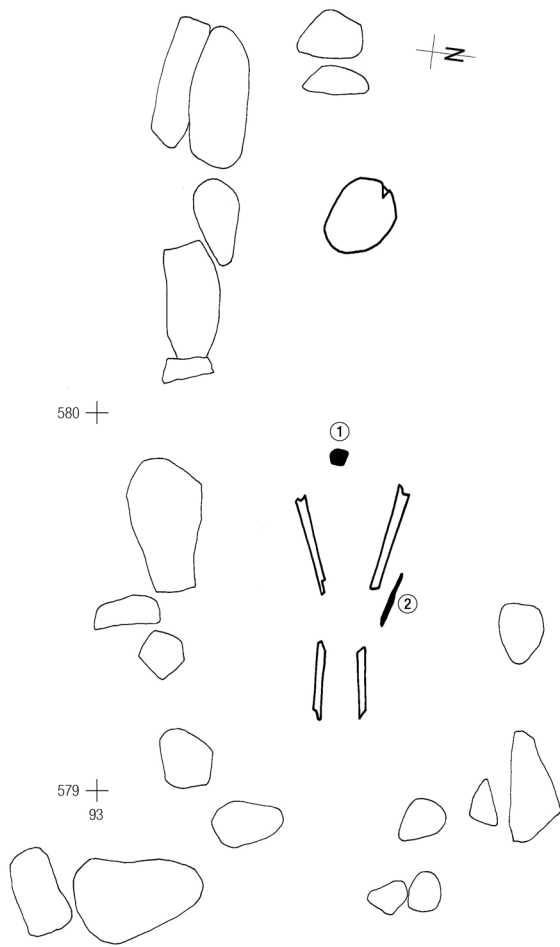

Grab 221

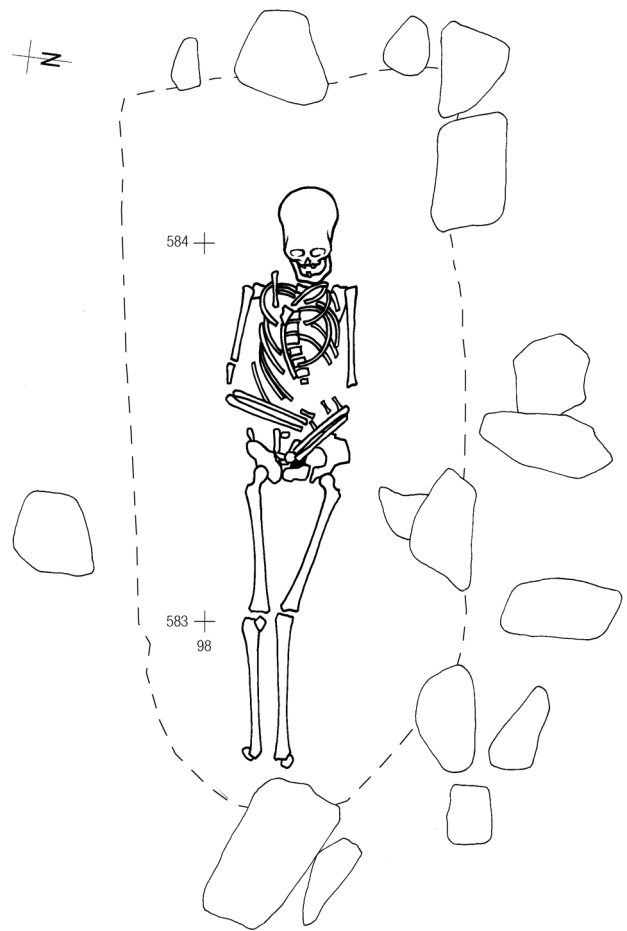

Grab 218

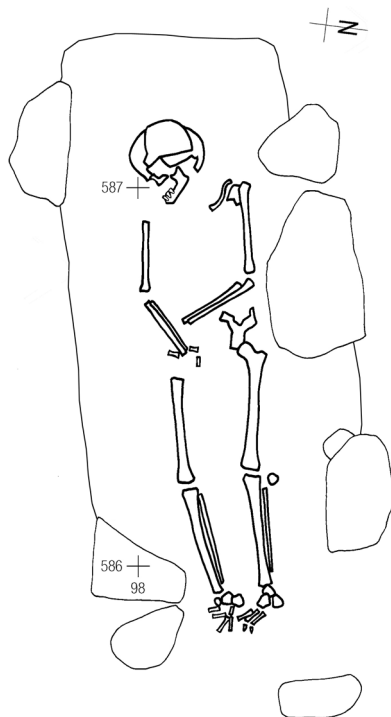

Gräber 223/224/225

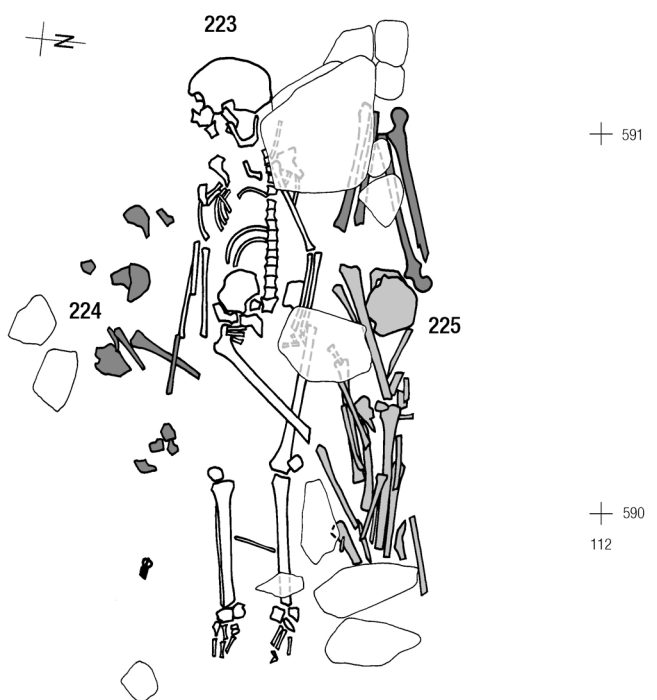

Grab 226

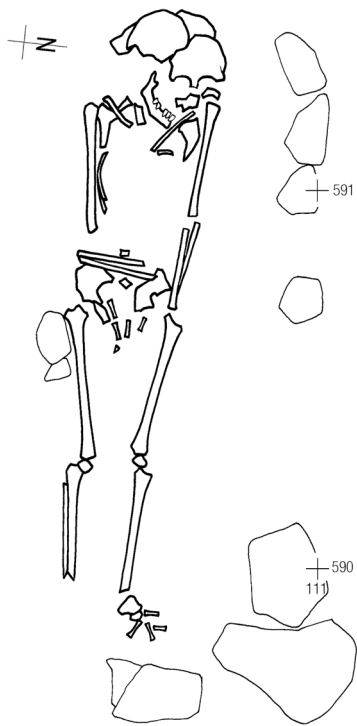

Grab 227

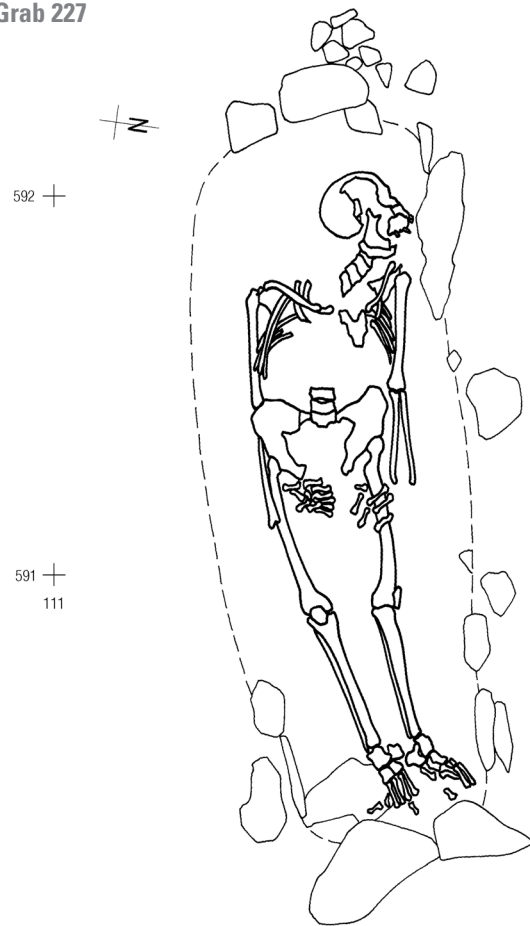

Grab 229

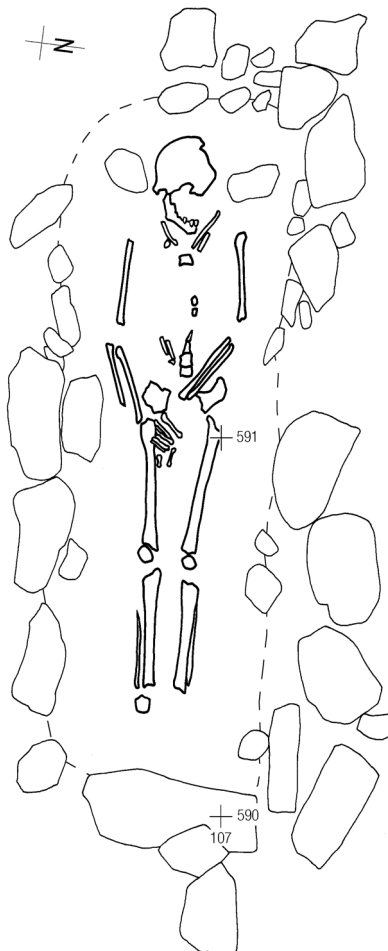

Gräber 231/263

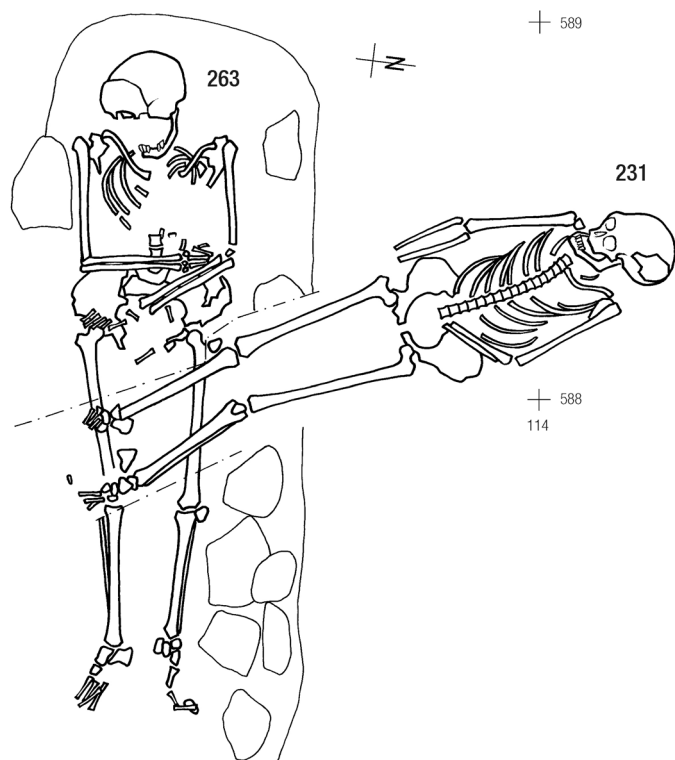

Grab 233

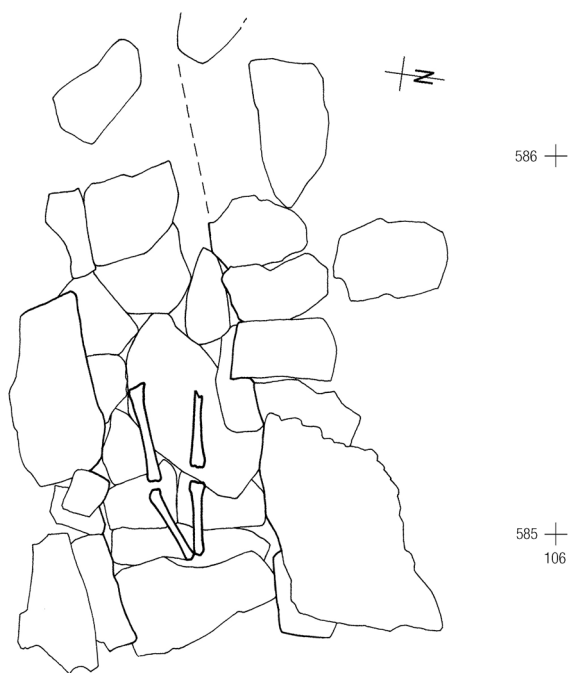

Grab 232

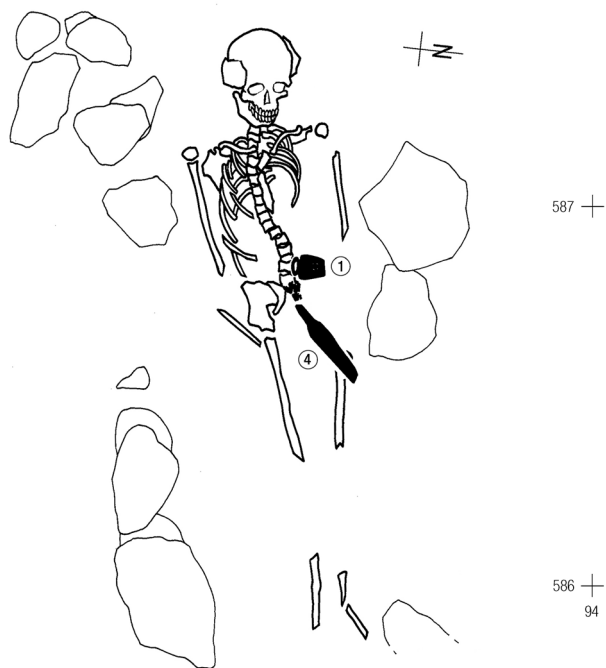

Grab 234



Gräber 235/353

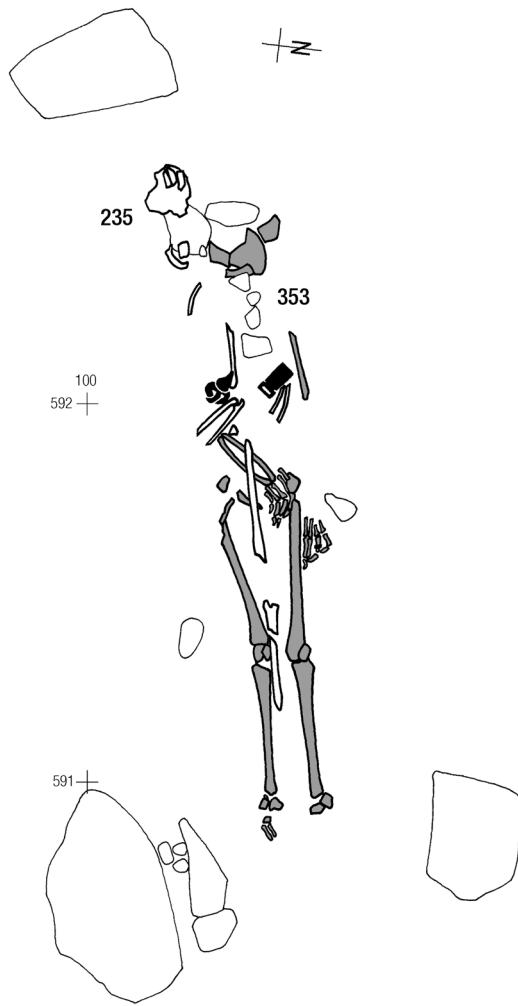

Grab 236

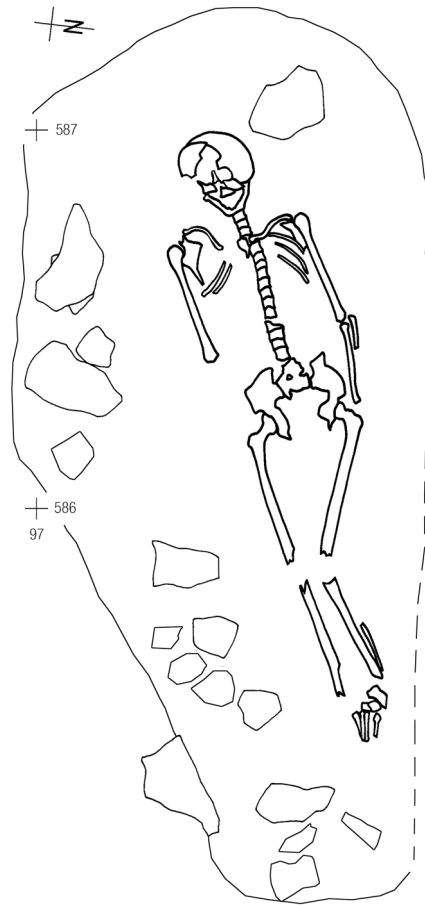

Grab 237



Grab 238

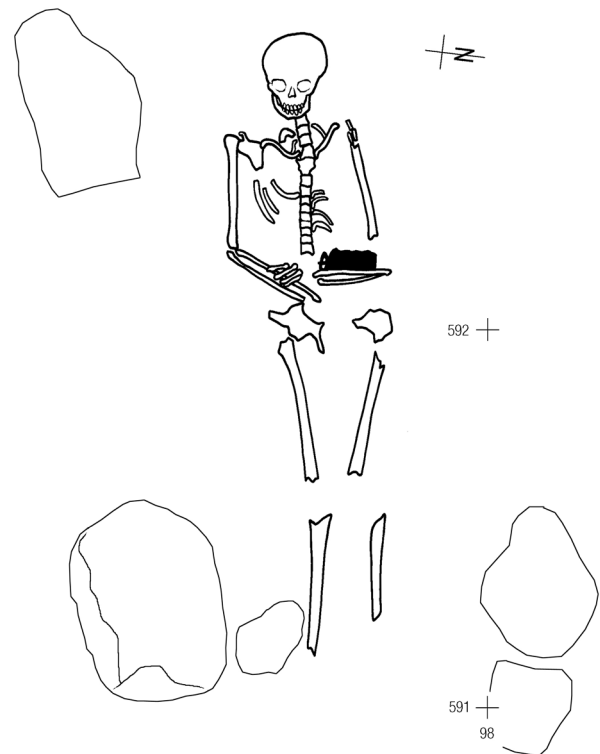

Gräber 239/243

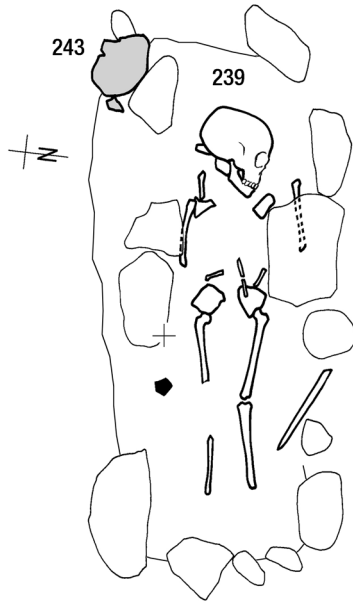

585 +  
94

Grab 240

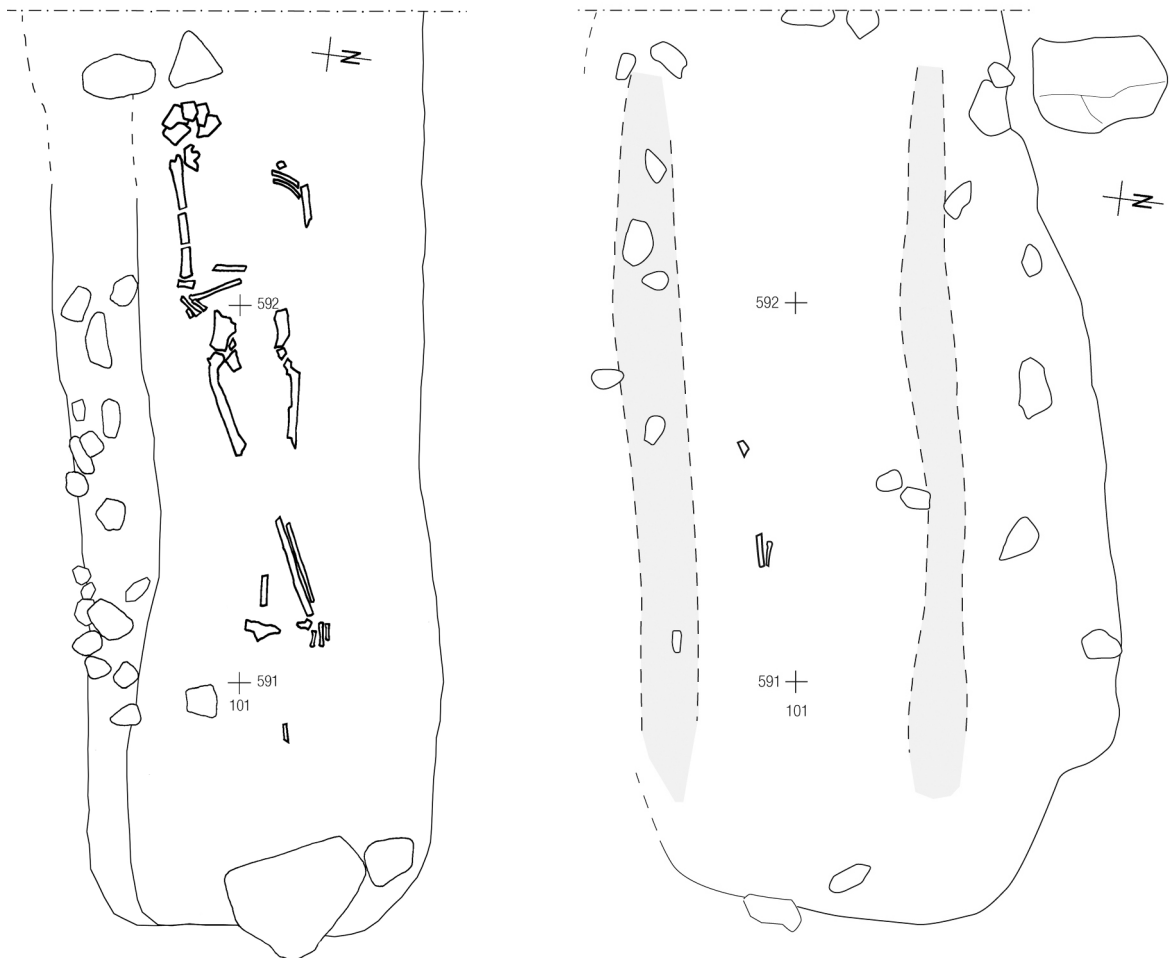

Niveau 1

Niveau 2

Grab 241

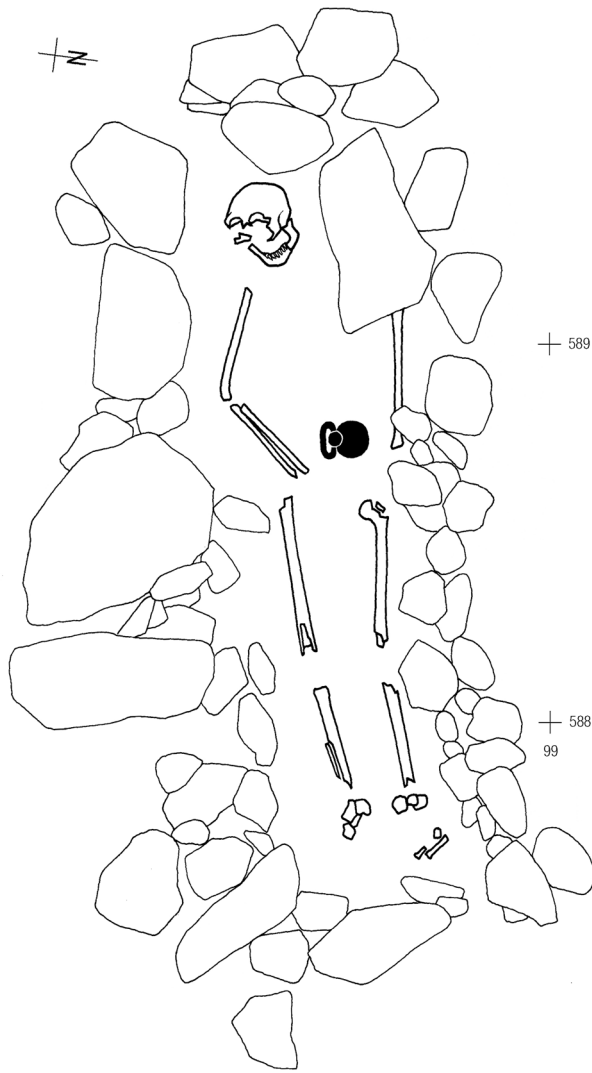

Grab 244

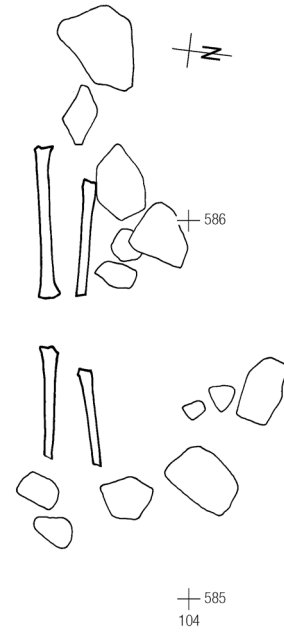

Grab 242



Grab 245

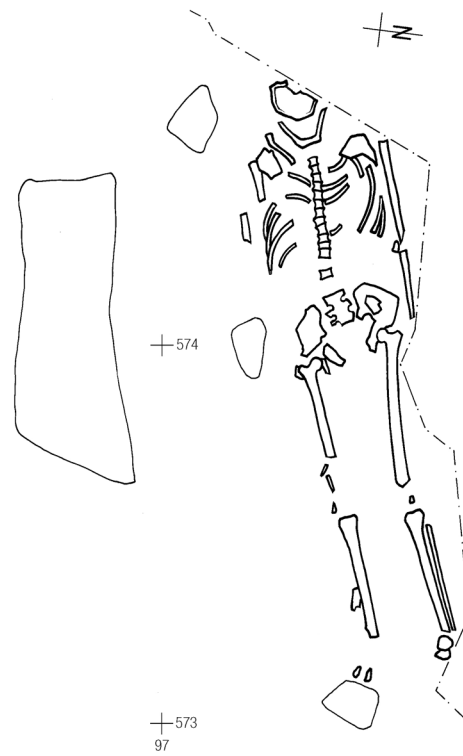



Grab 246

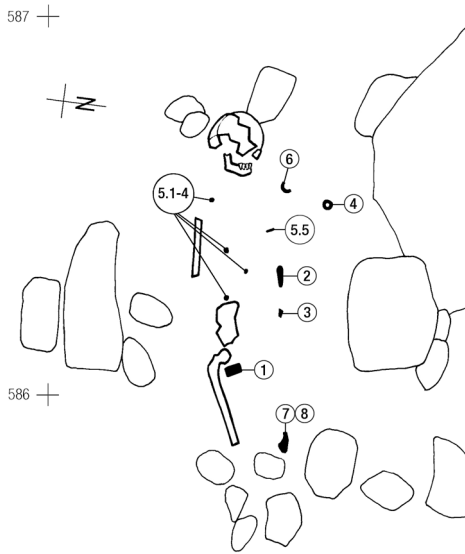

Grab 247

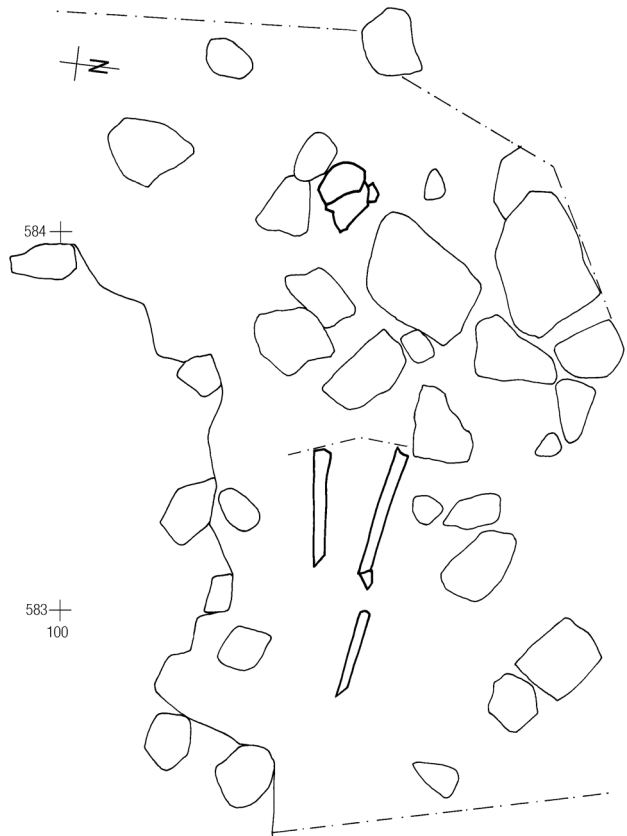

Grab 248

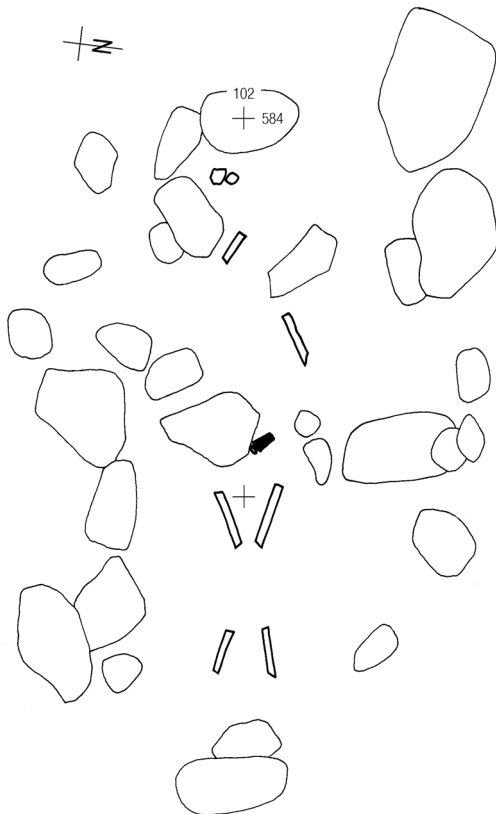

Grab 249

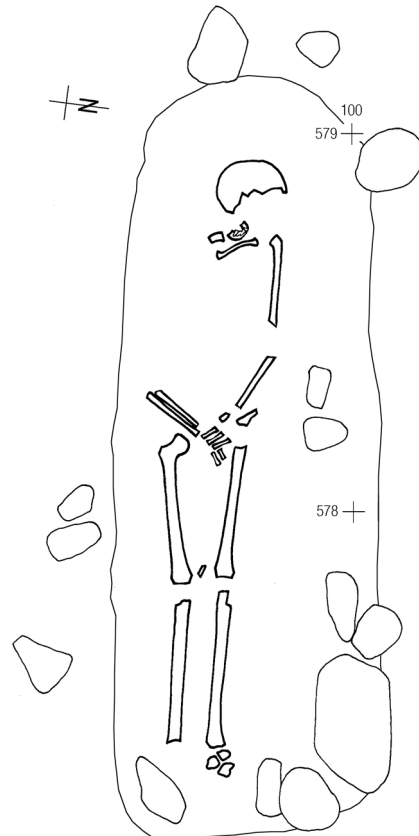

Grab 250

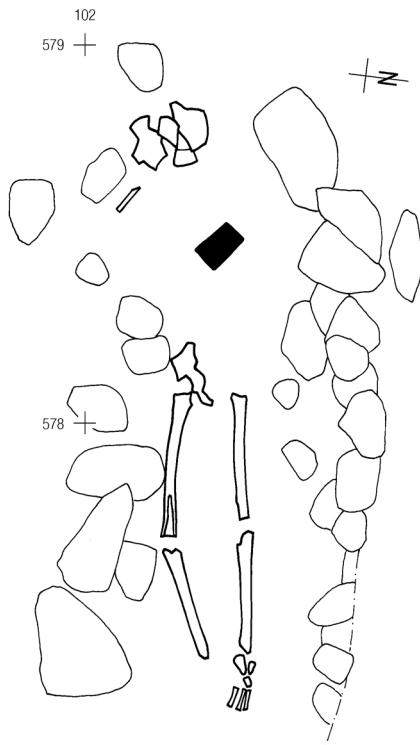

Grab 252

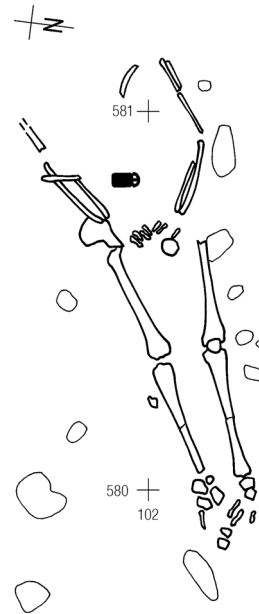

Grab 251

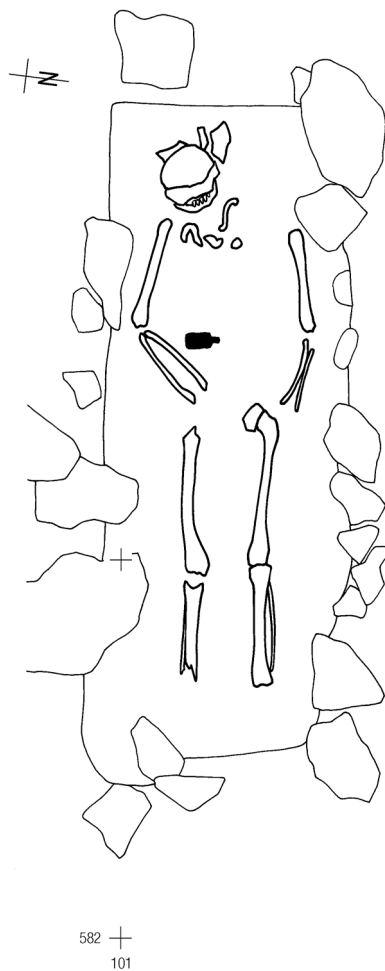

Gräber 253/254/271/325

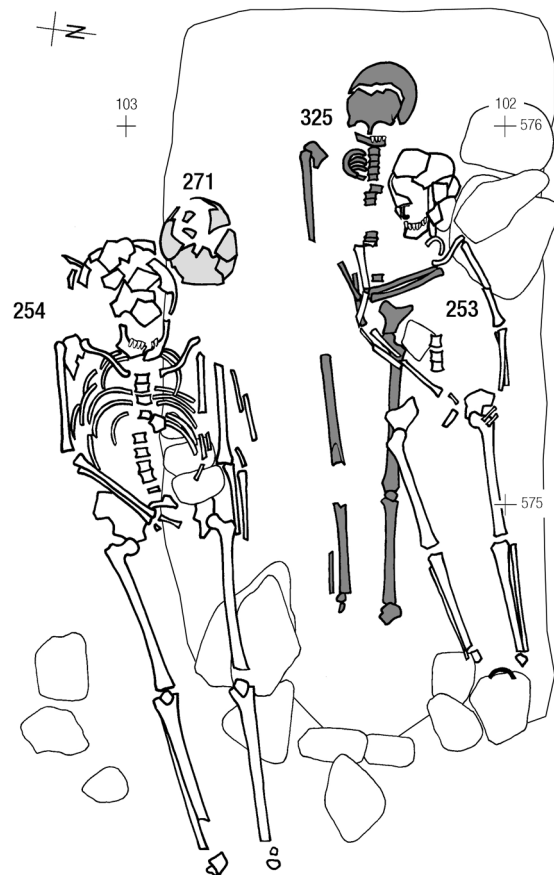

Grab 255

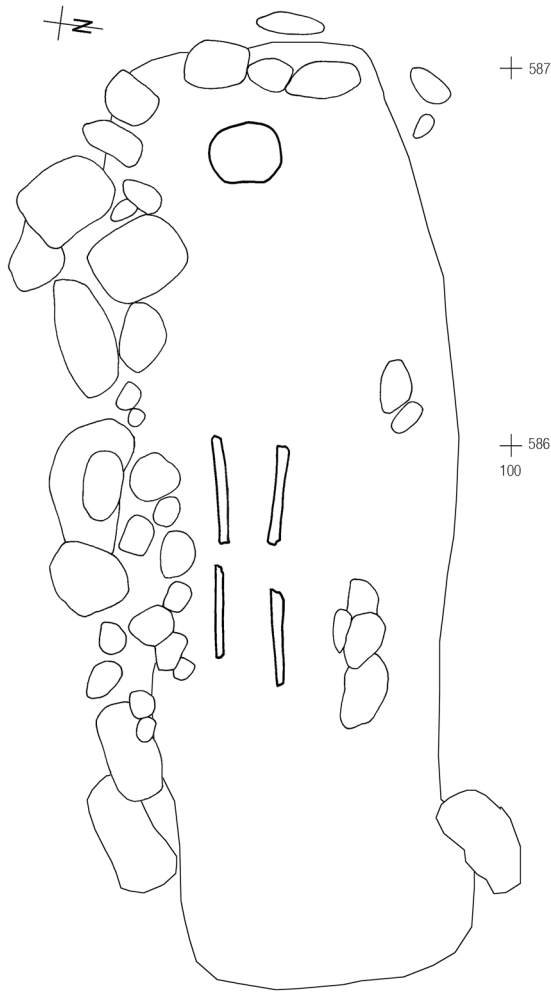

Gräber 258/259/265/268/270

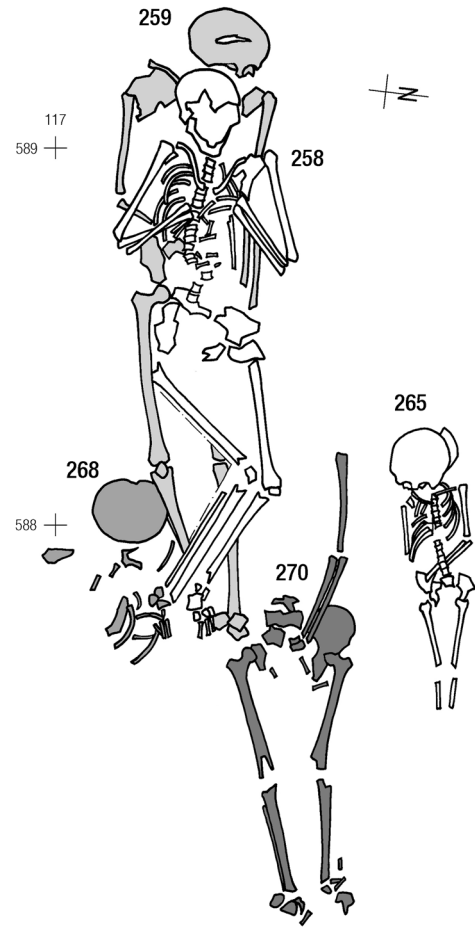

Gräber 256/257

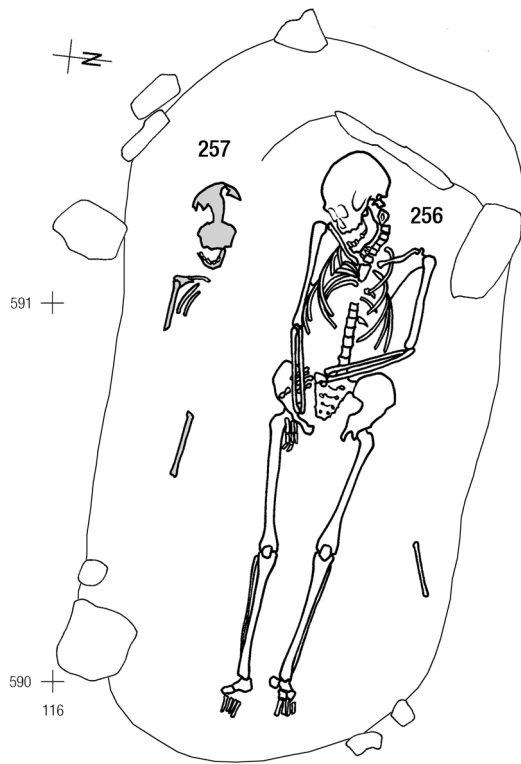

Grab 260

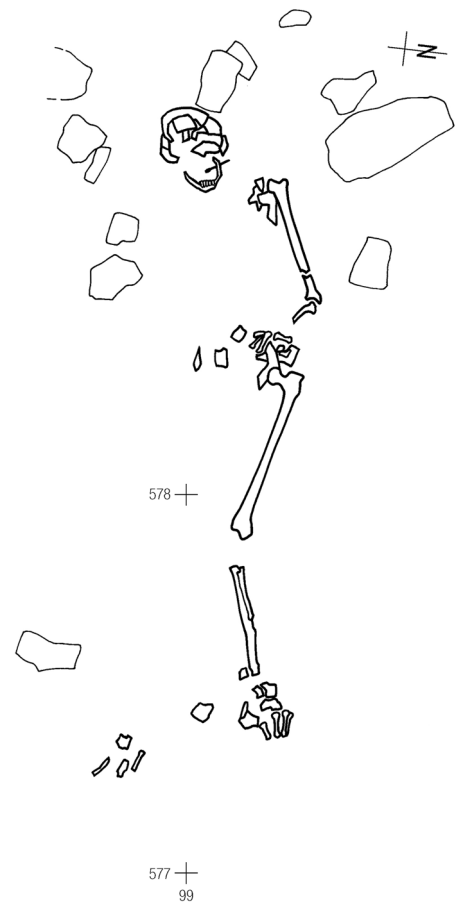

Grab 261

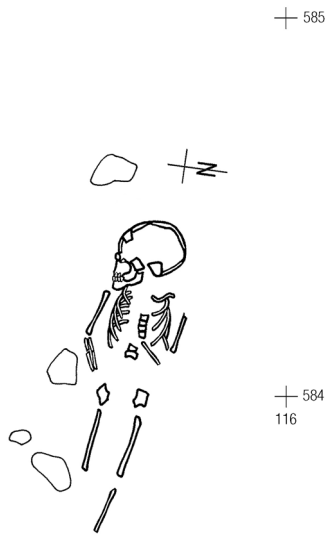

Grab 262



Grab 266



Grab 264

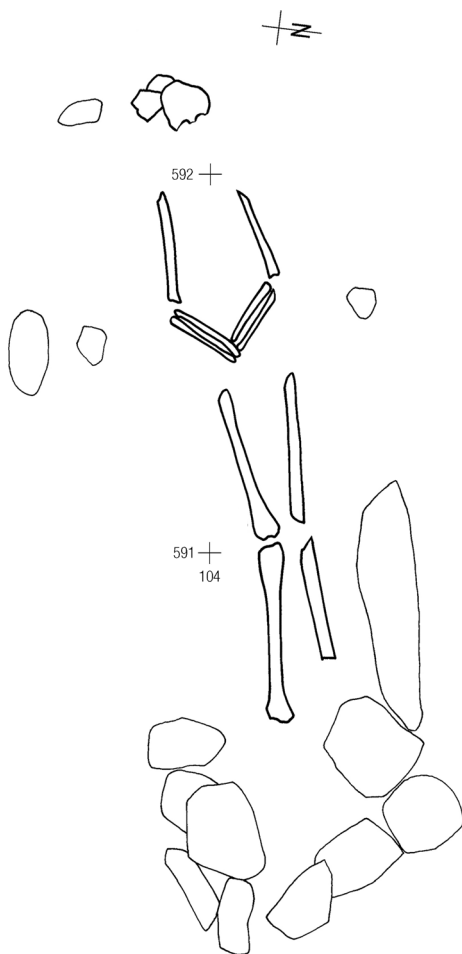

Grab 267

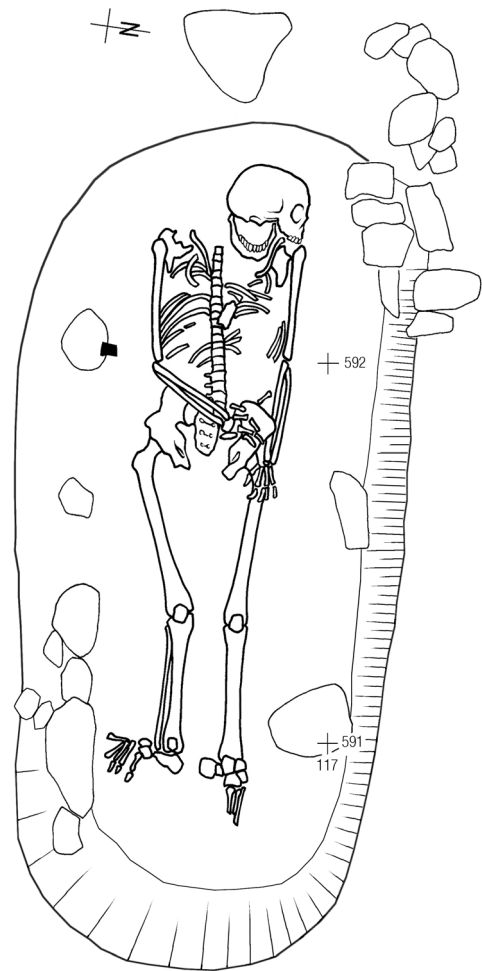

Grab 269

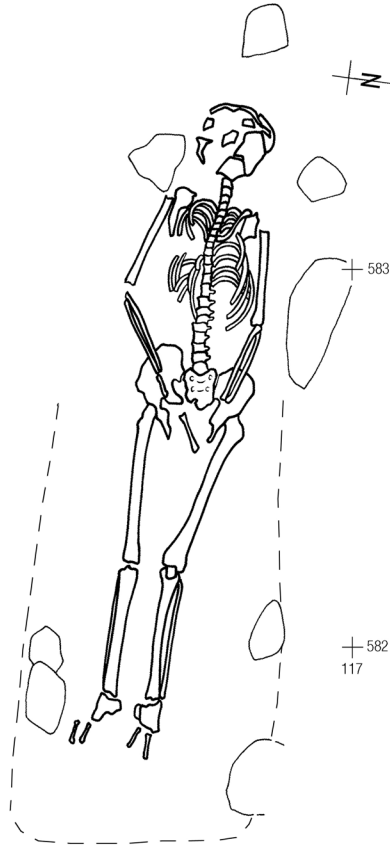

Grab 272

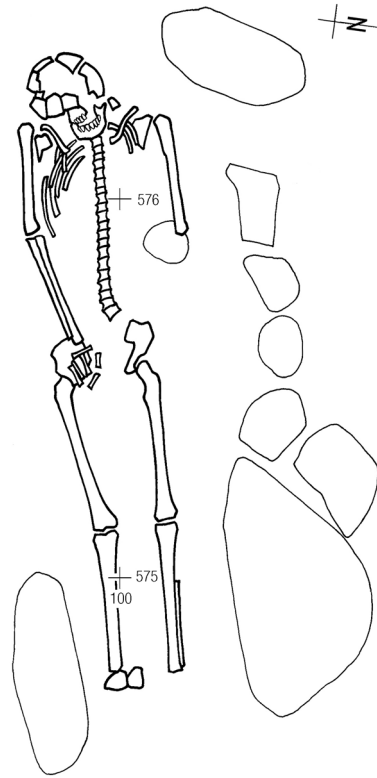

Gräber 273/286

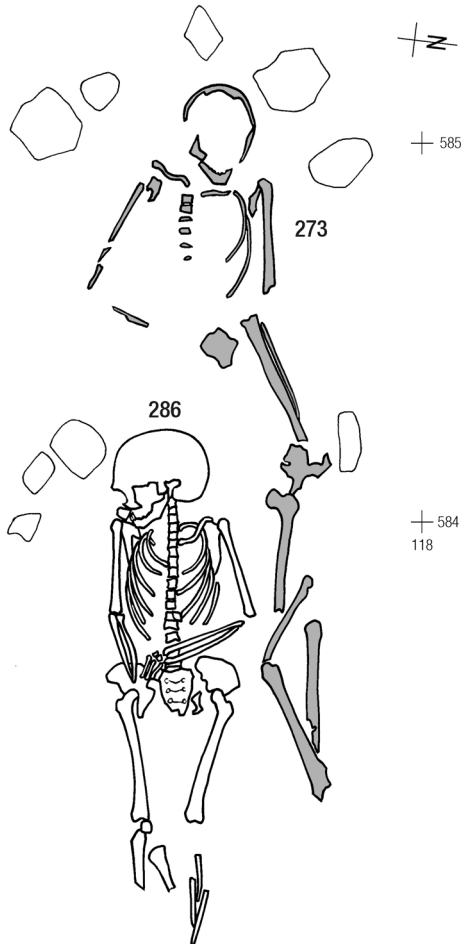

Grab 274

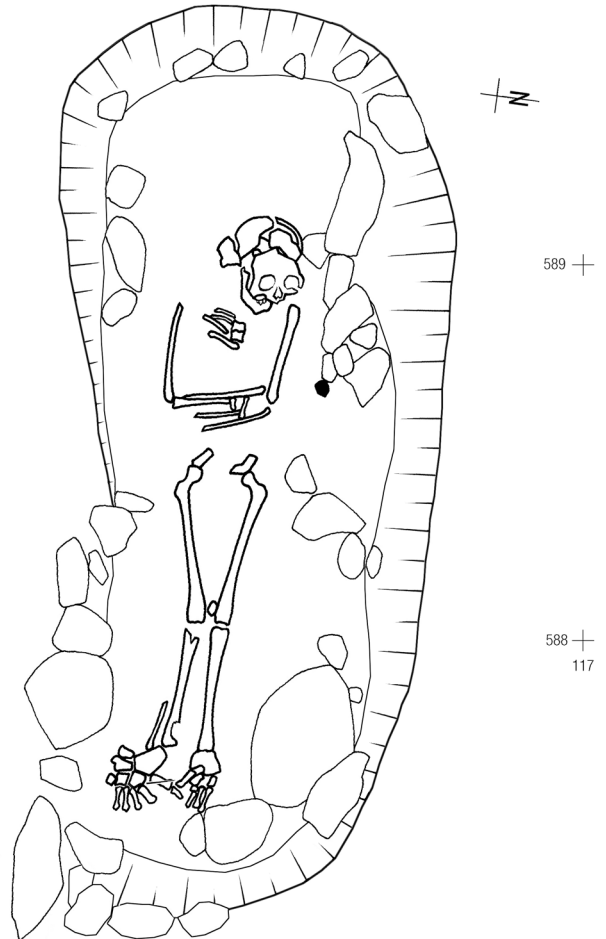

Gräber 275/324/328

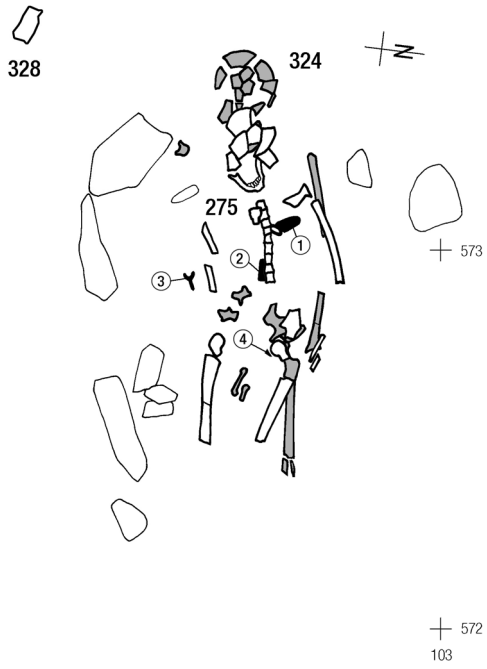

Grab 277

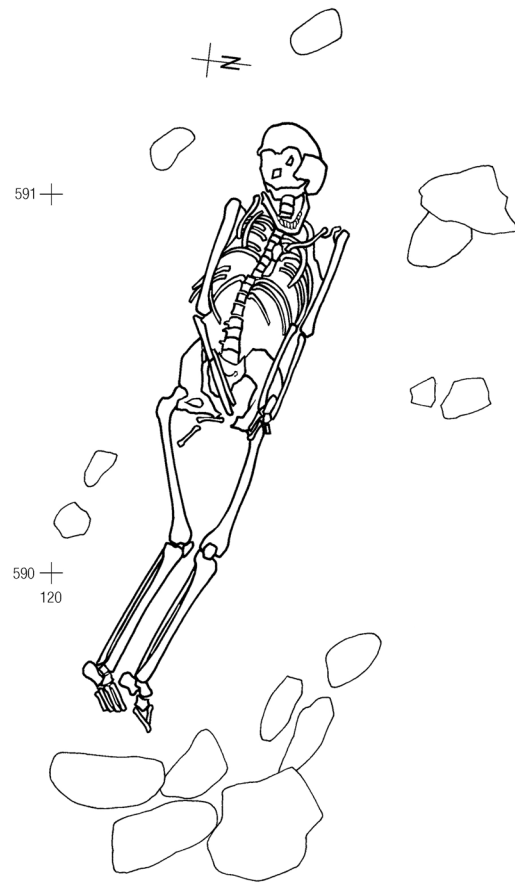

Grab 276

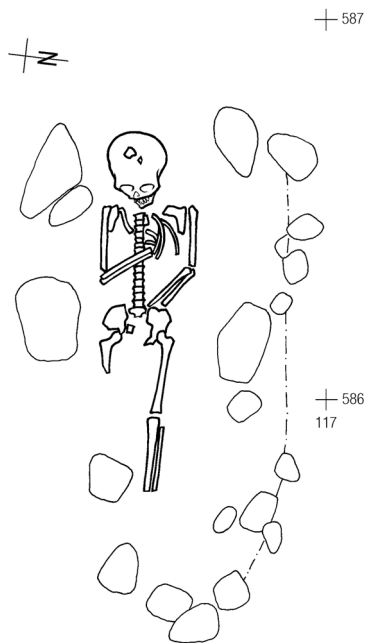

Grab 278

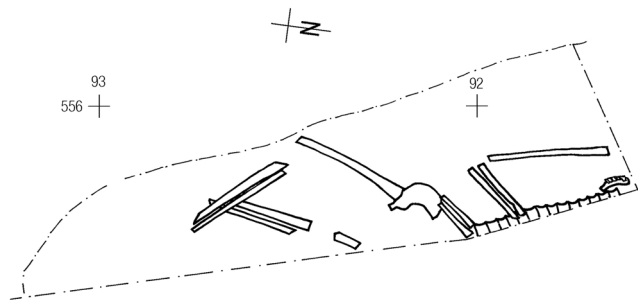

Gräber 279/381

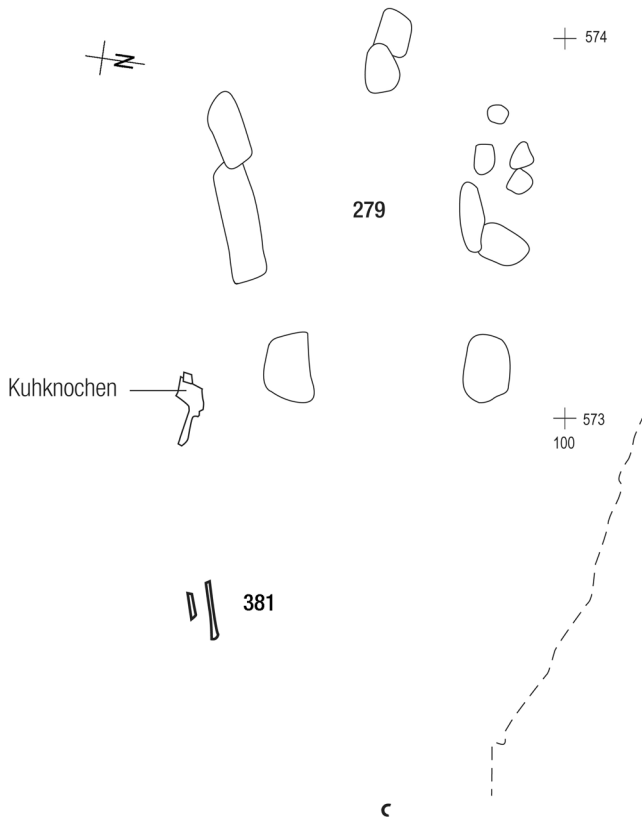

Gräber 281/282/283

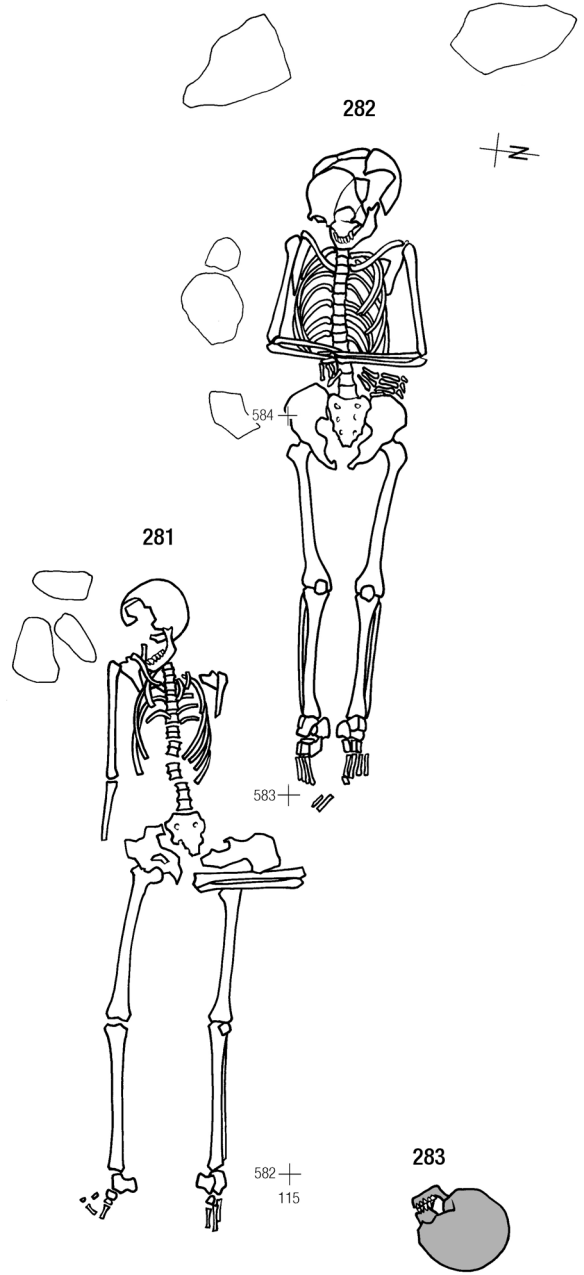

Grab 280

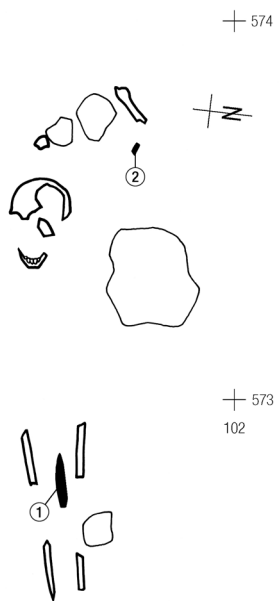

Grab 284

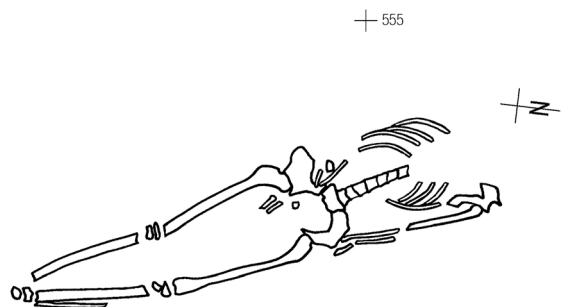

Gräber 289/300

Grab 287

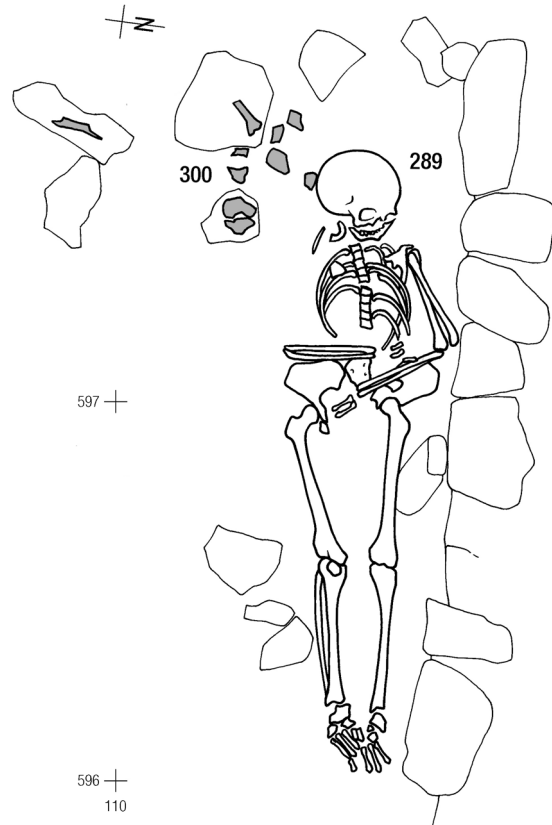
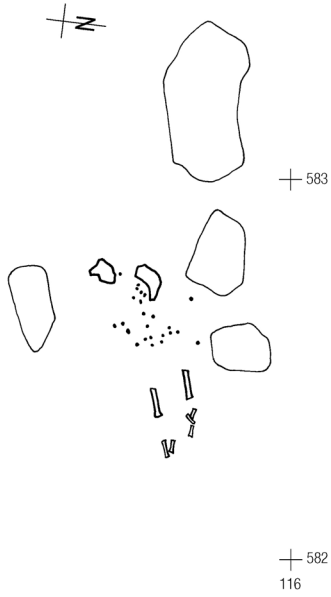

Grab 288

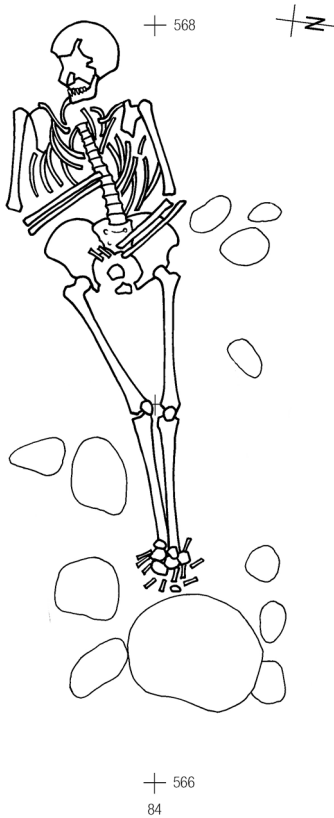

Grab 290

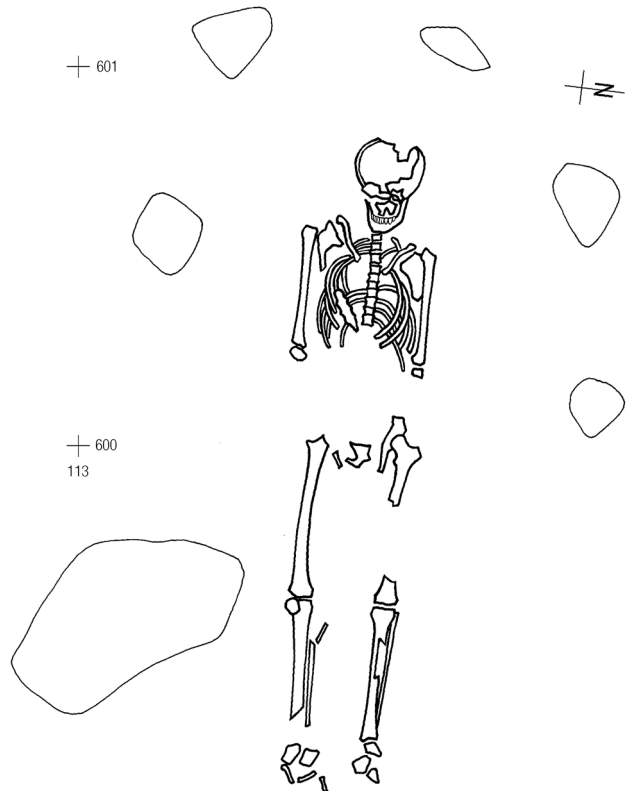



Grab 291

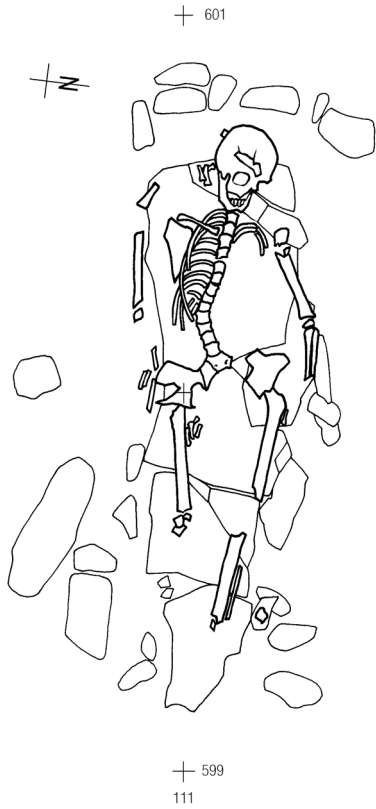

Grab 292

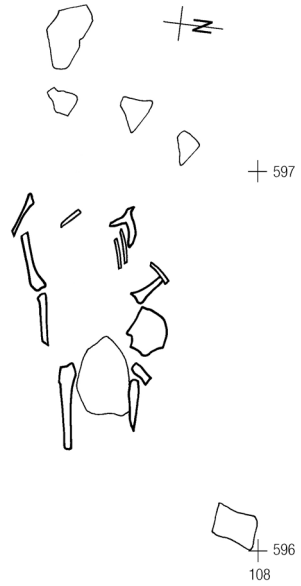

Gräber 293/299/301

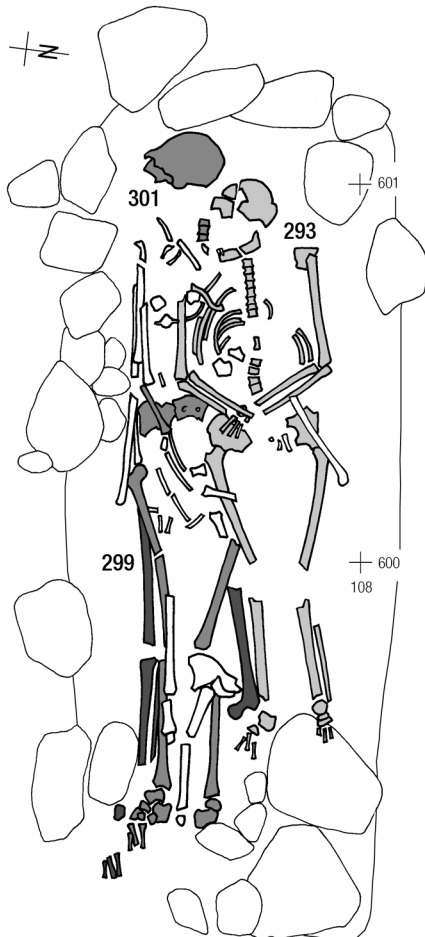

Grab 294

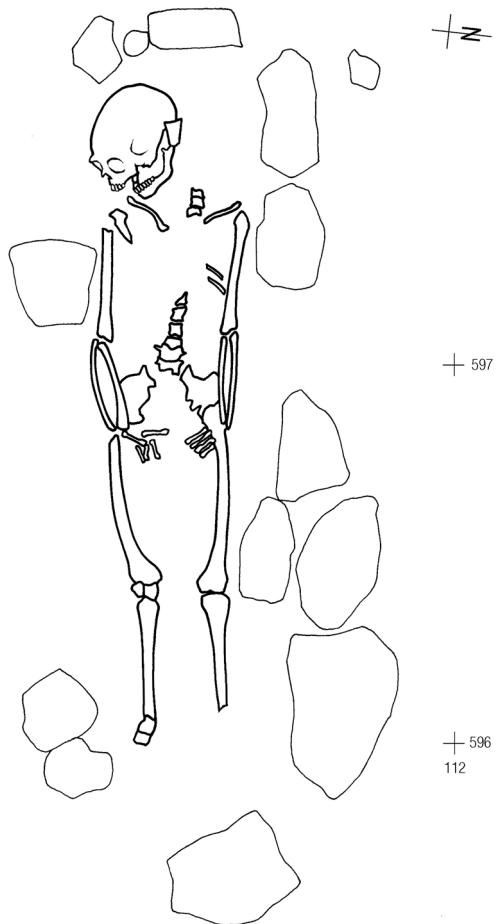

weisse Knochen = nicht zugeordnet

Gräber 295/296

112  
598 +

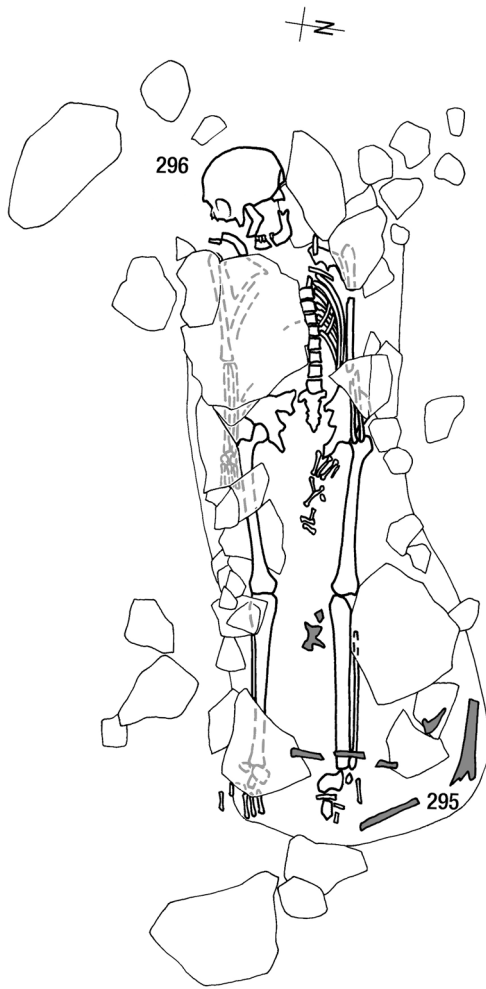

Gräber 297/298

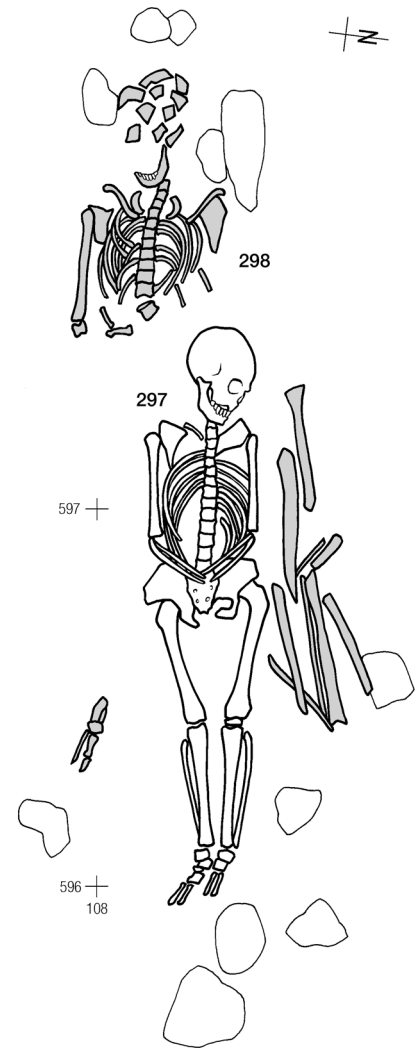

Grab 302

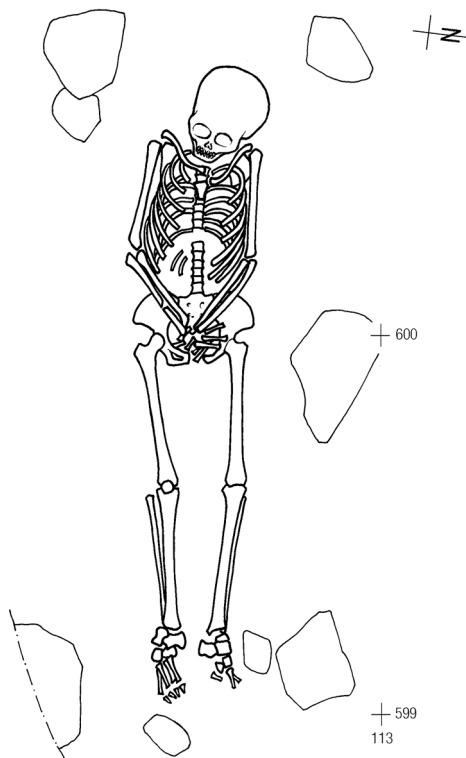

Gräber 303/308

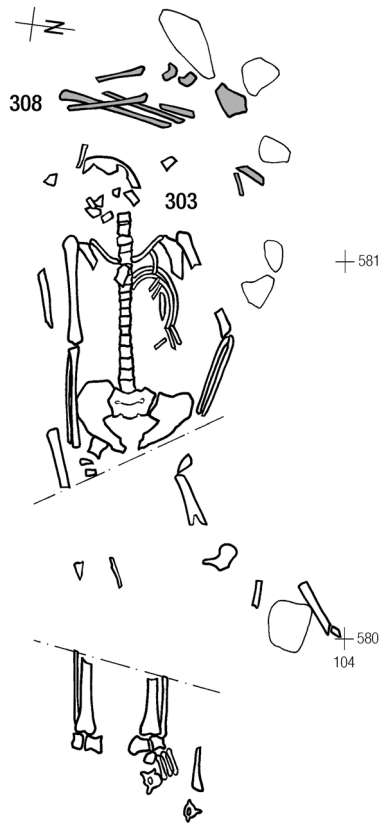

Grab 304

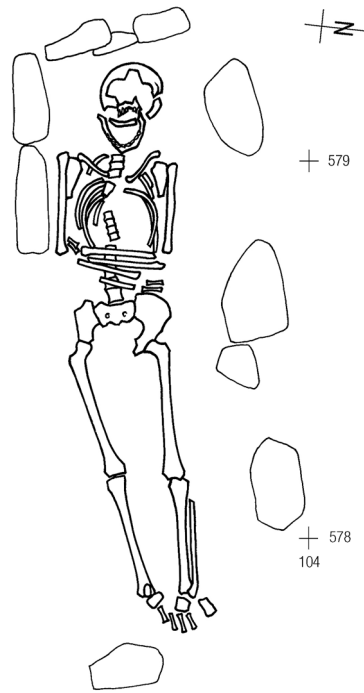

Grab 305

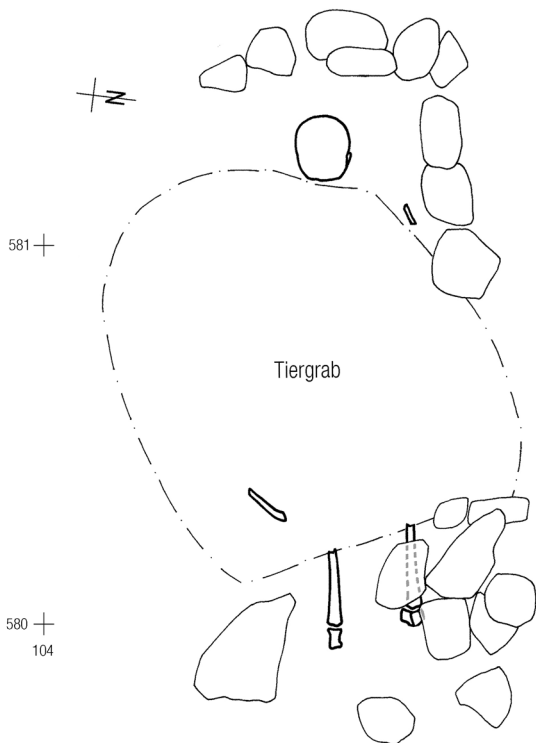

Gräber 306/307

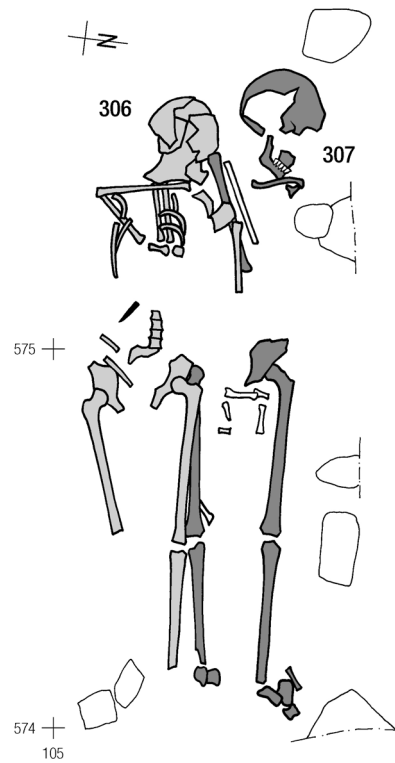

Grab 309

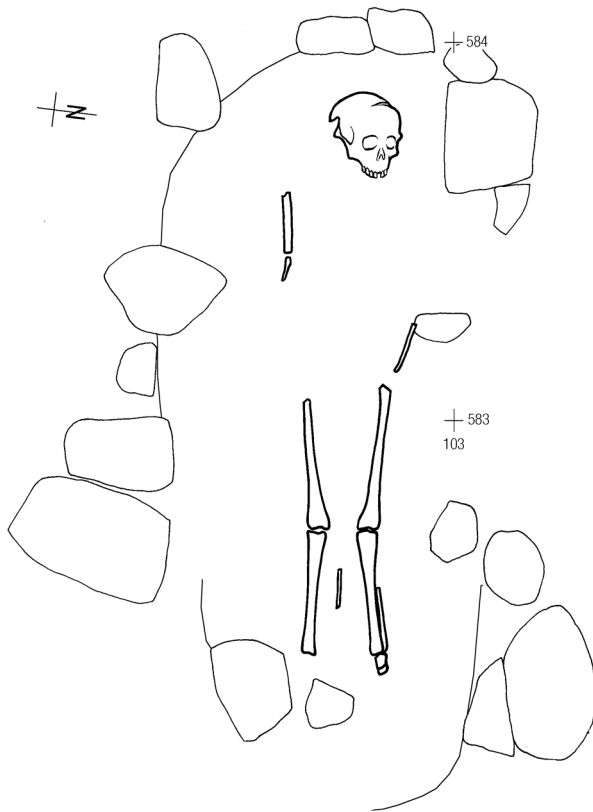

Grab 310

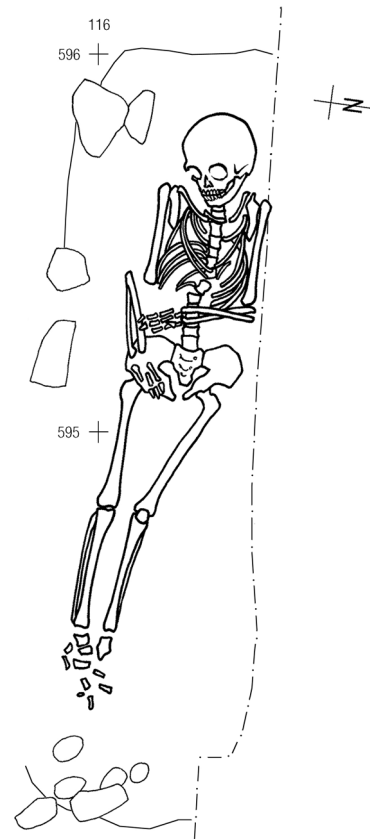

Gräber 311/312

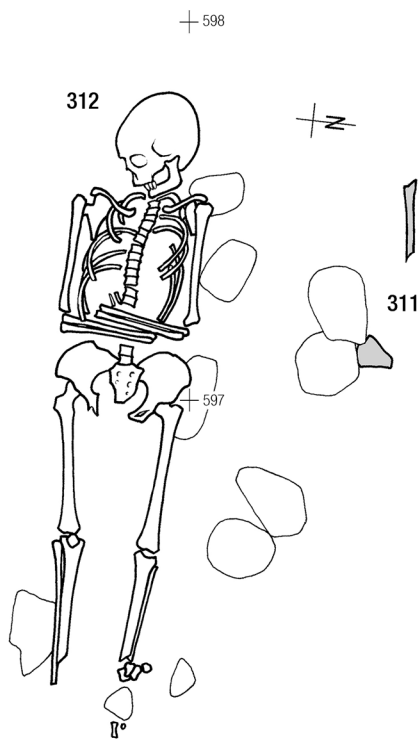

Grab 313

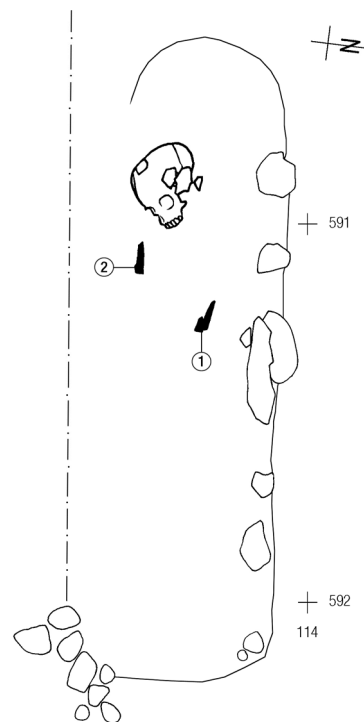

Gräber 314/315

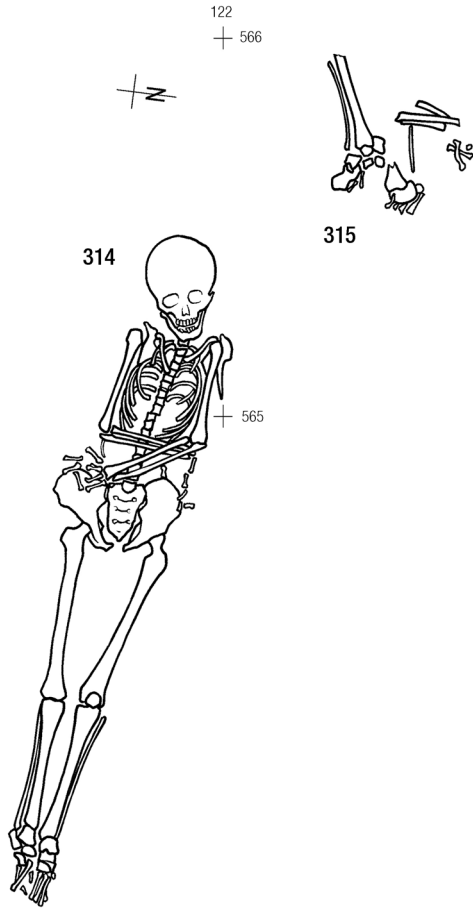

Grab 316

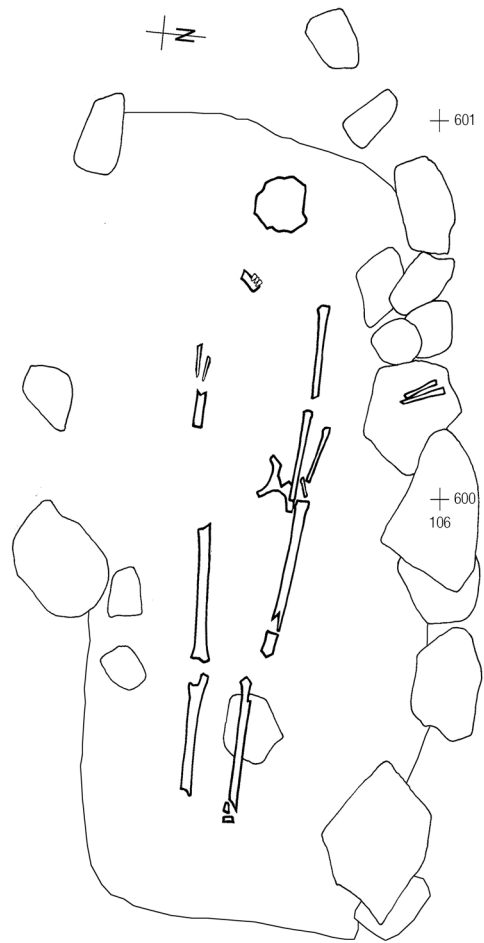

Gräber 317/318/320

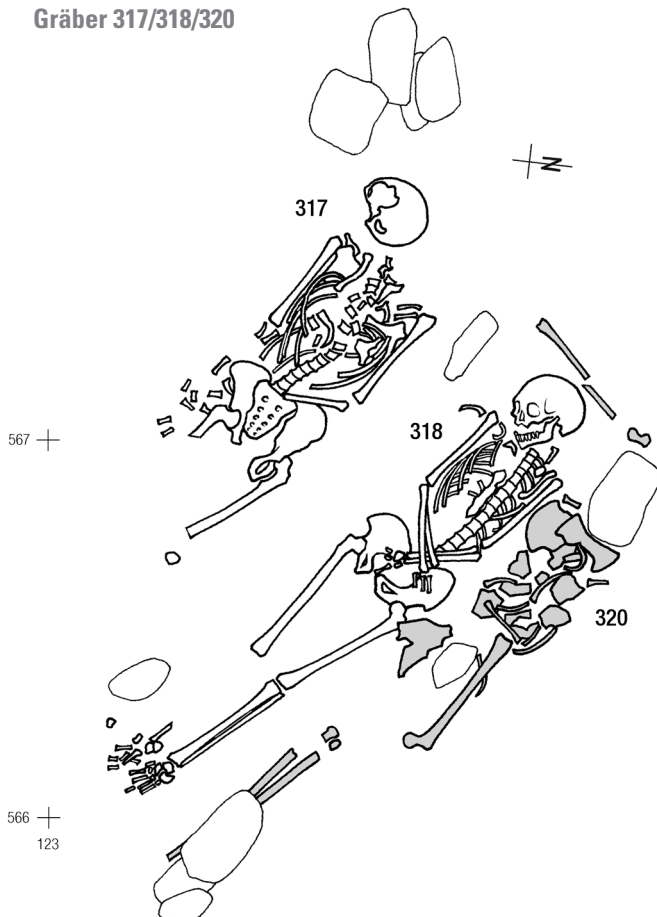

Grab 319

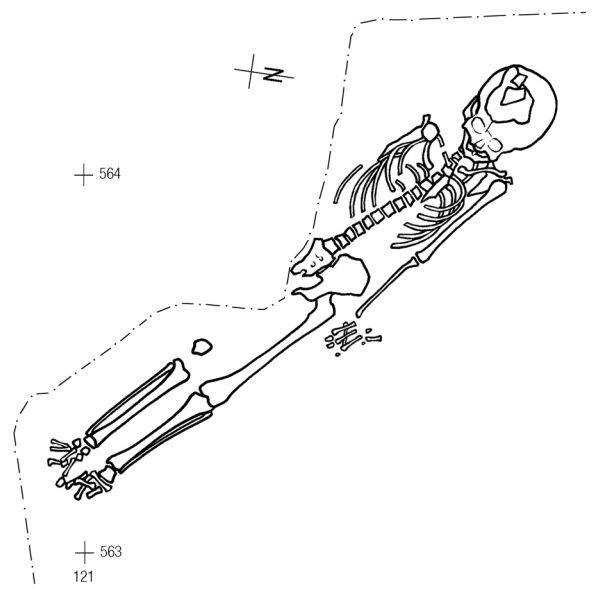

Grab 321

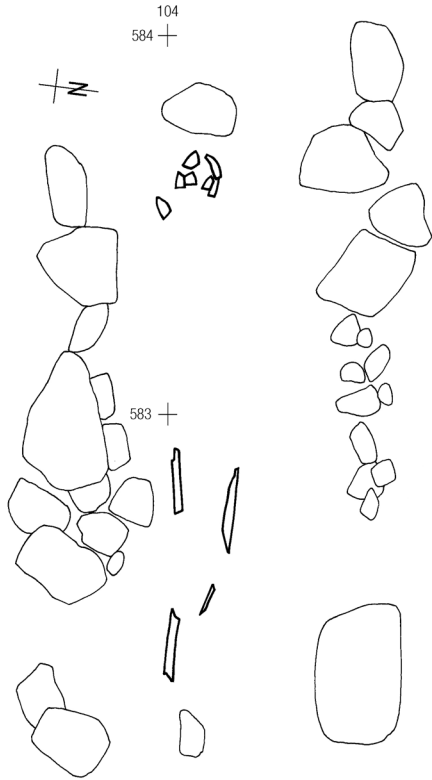

Gräber 324/328

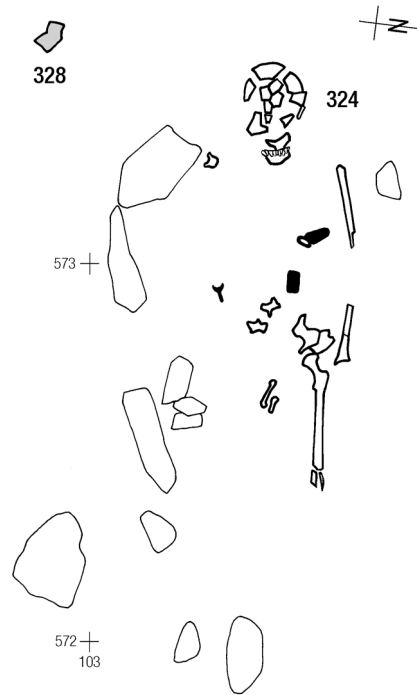

Grab 323



Gräber 326/327

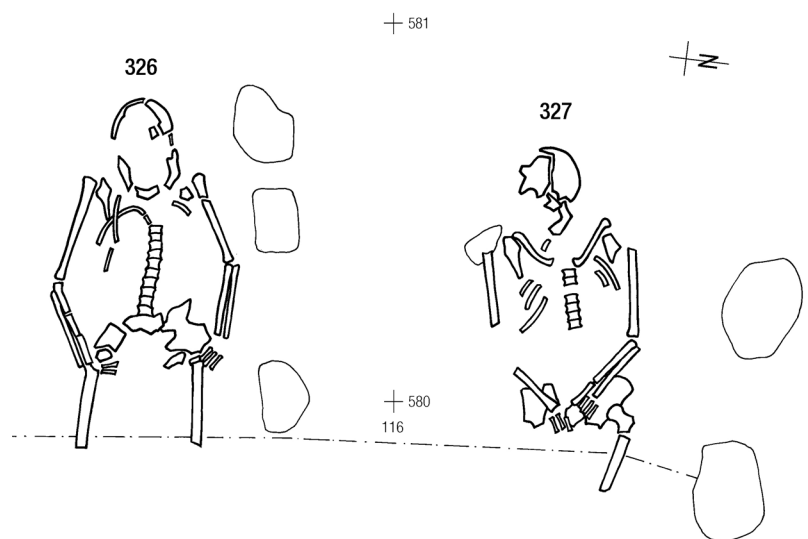

Gräber 329/331/335

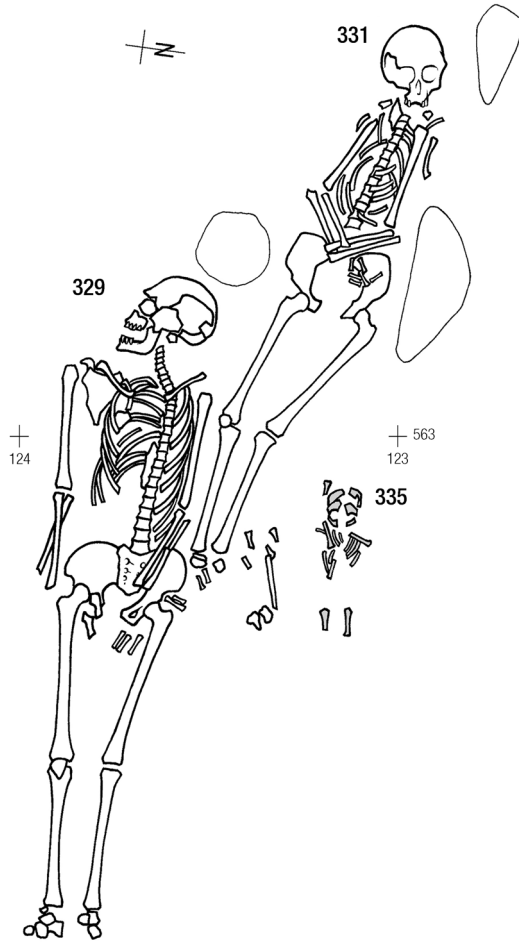

Grab 330



Grab 332

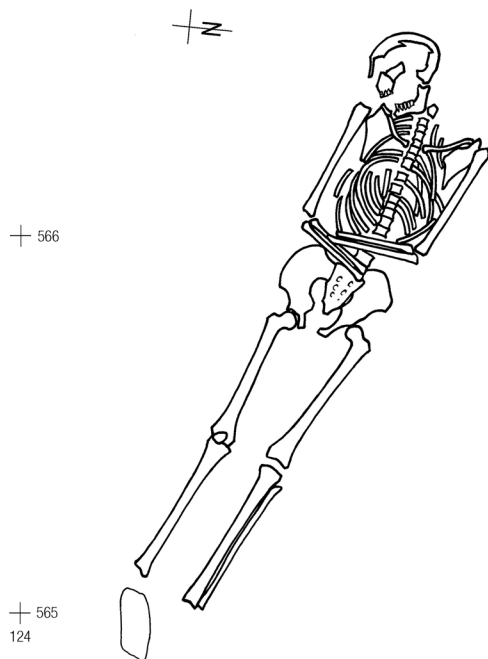

Grab 333

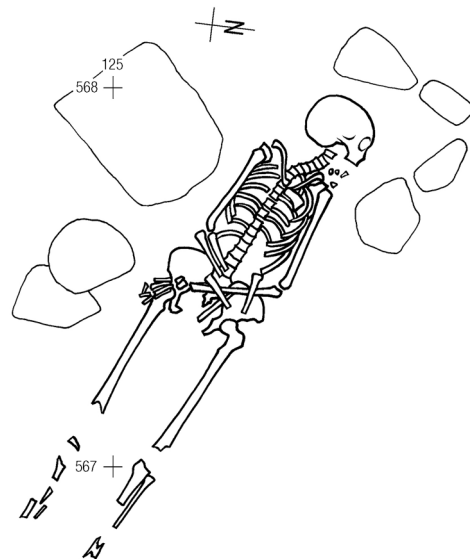

Gräber 334/339

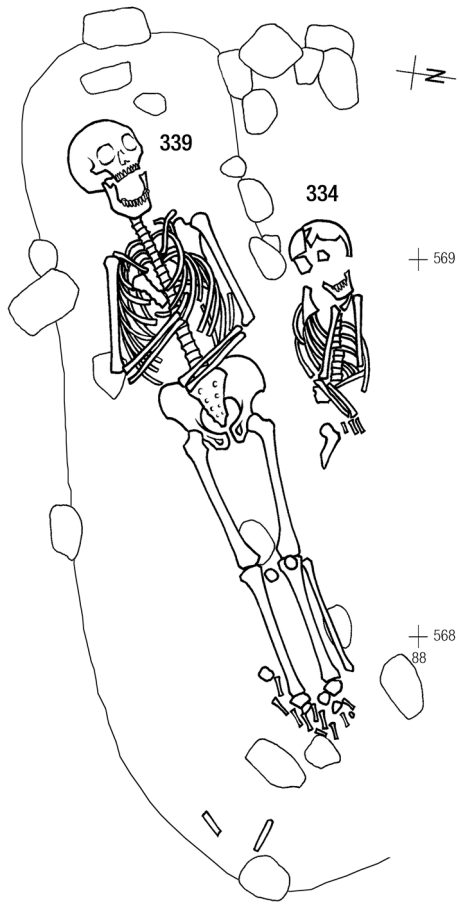

Grab 336

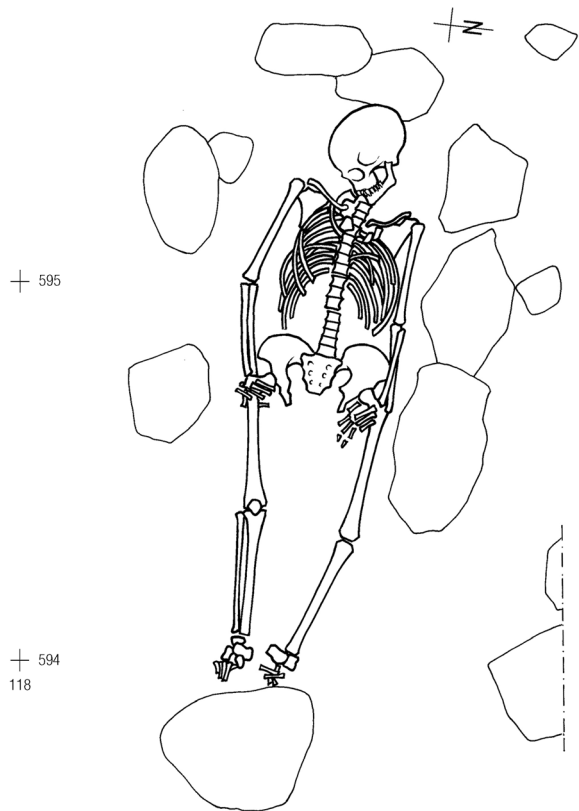

Grab 337

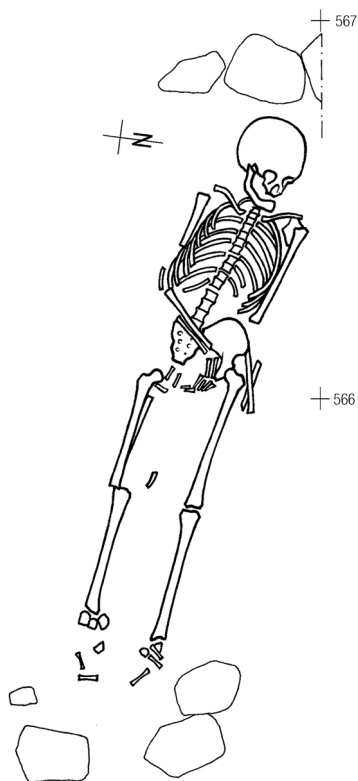

Grab 338

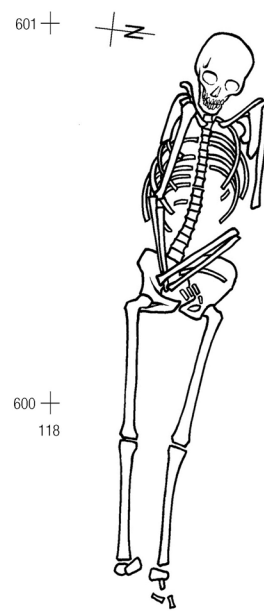



Grab 340

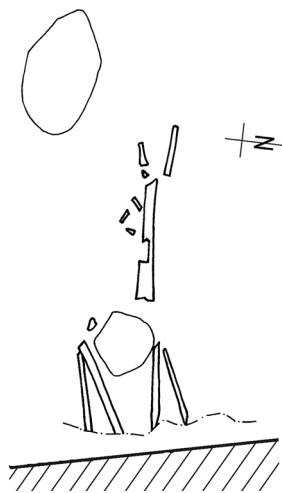

Grab 341

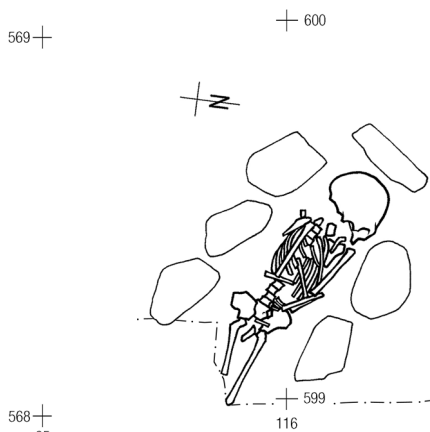

Grab 342

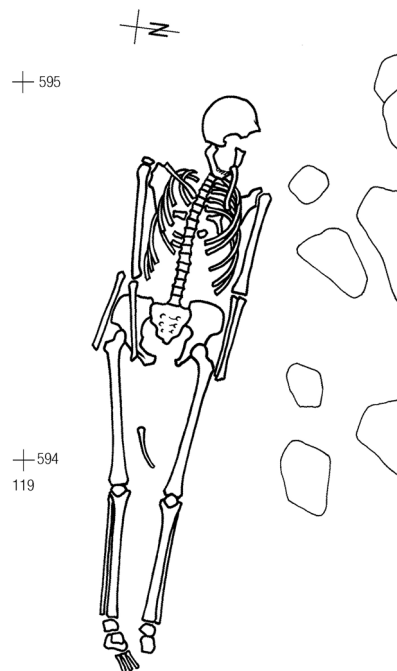

Gräber 343/346

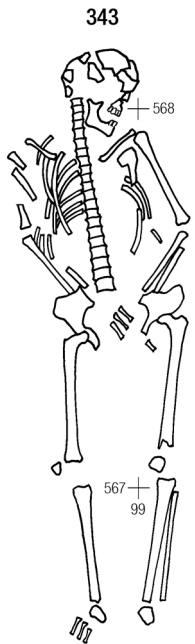

Grab 344

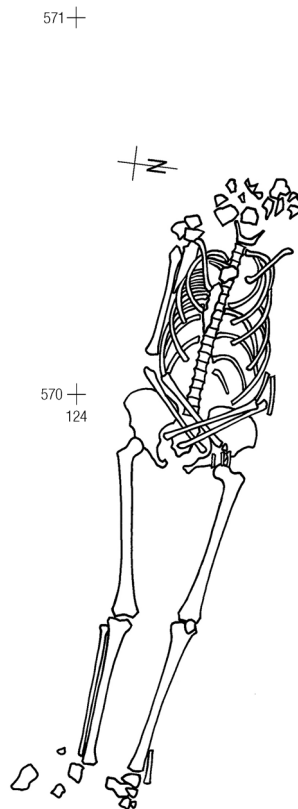

Grab 345



Grab 347

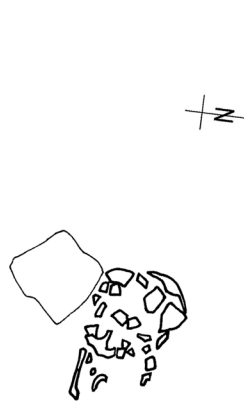

Grab 349

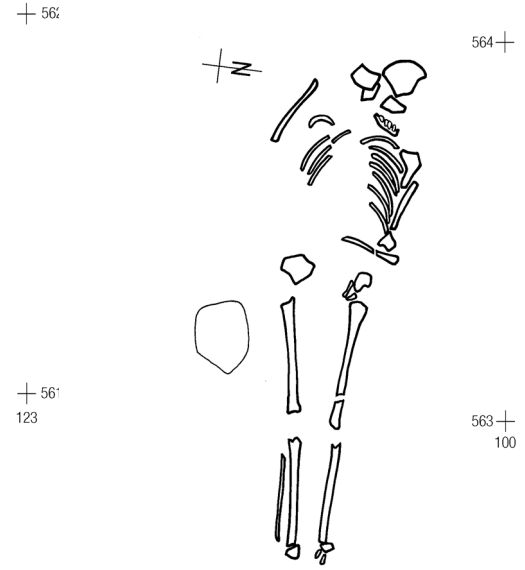

Grab 348

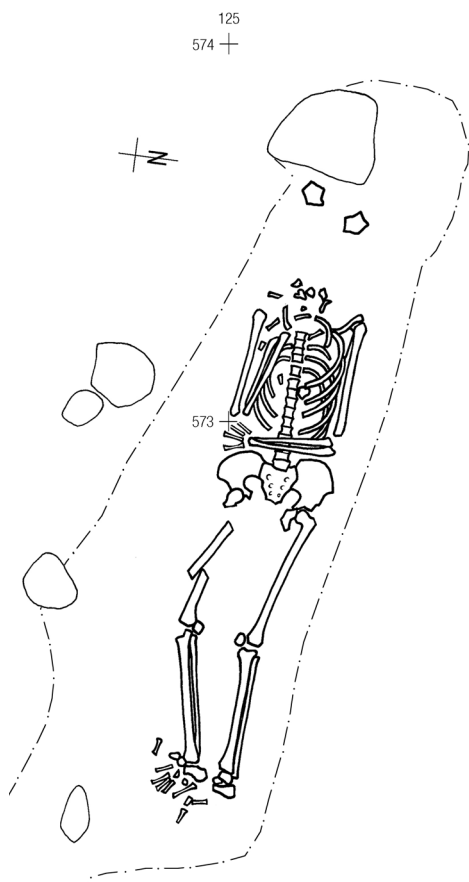

Gräber 350/354/359

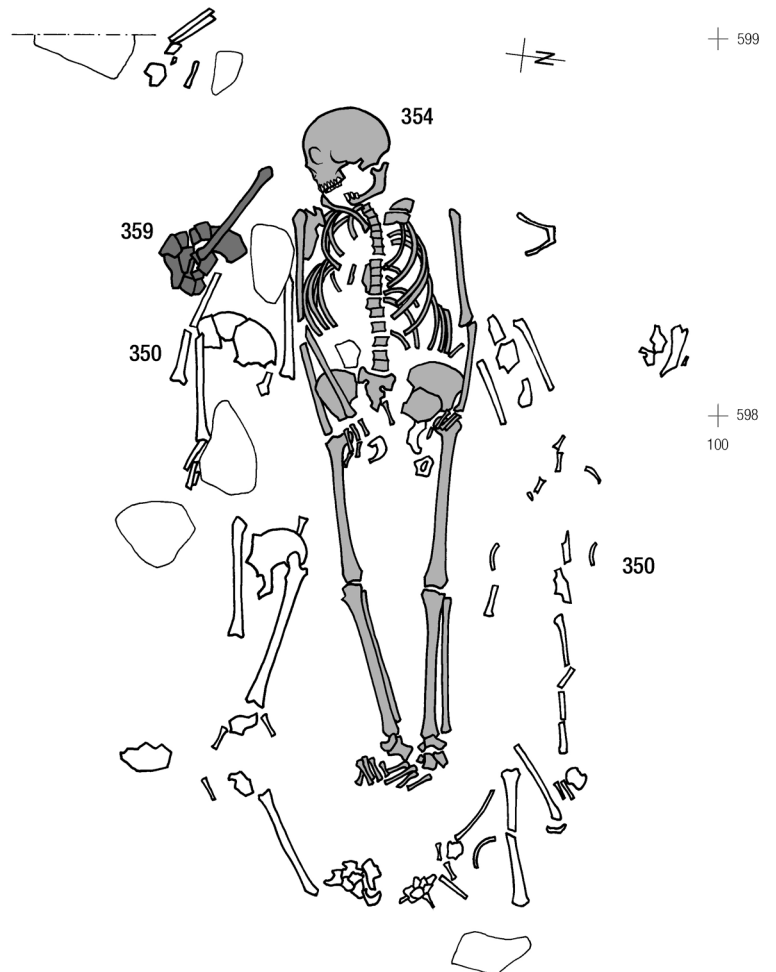

Grab 351

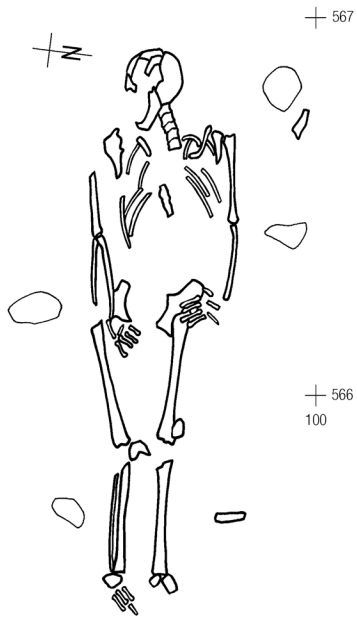

Grab 352

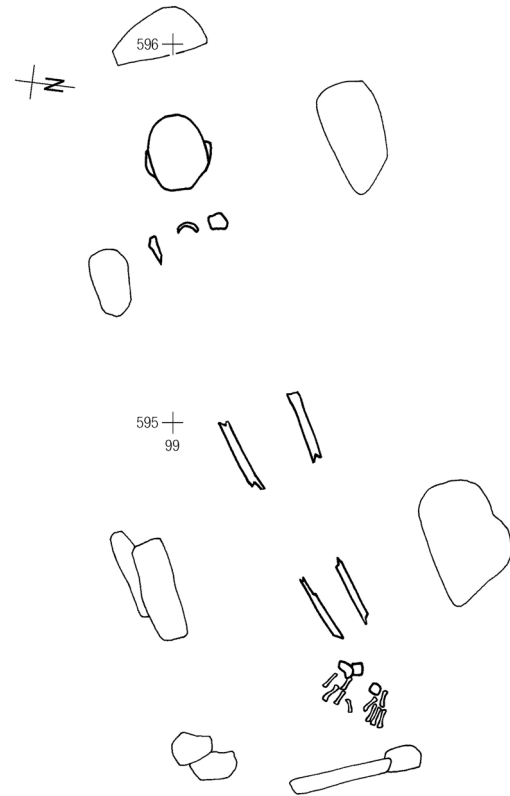

Grab 353

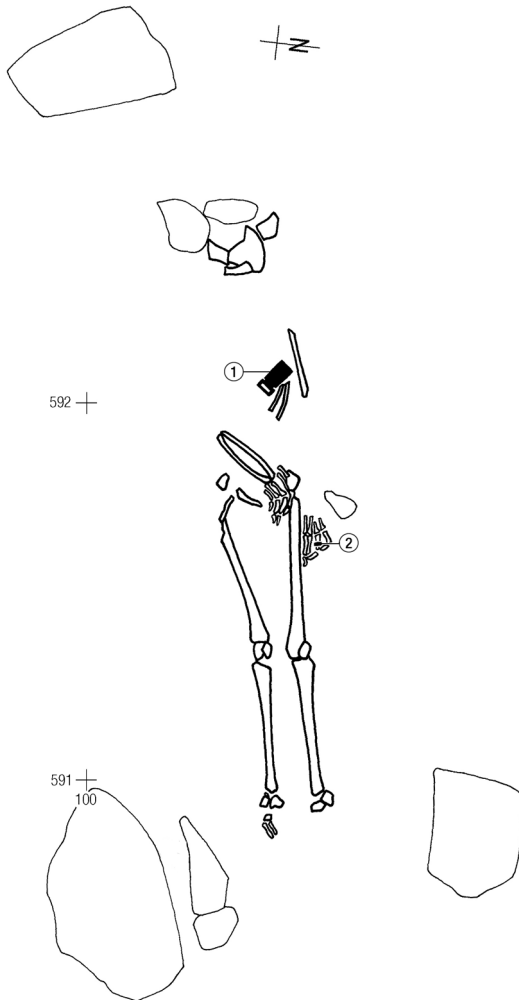

Grab 355

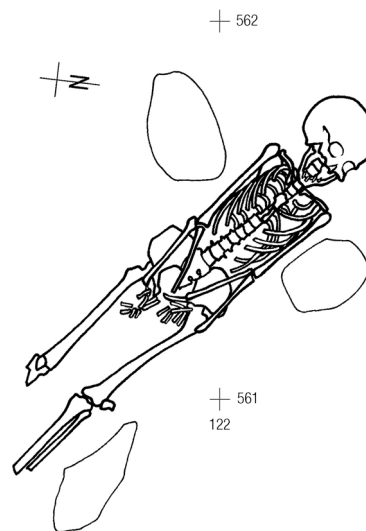

siehe auch Gräber 235/253

Grab 356

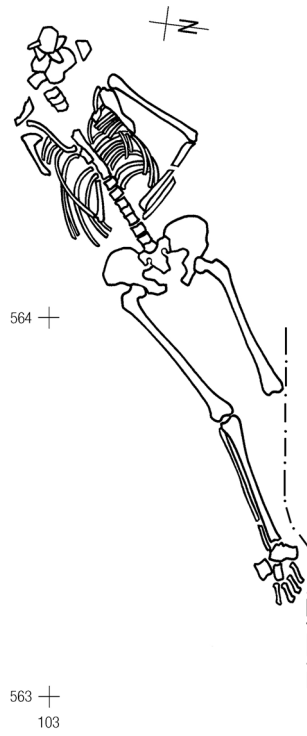

Grab 357

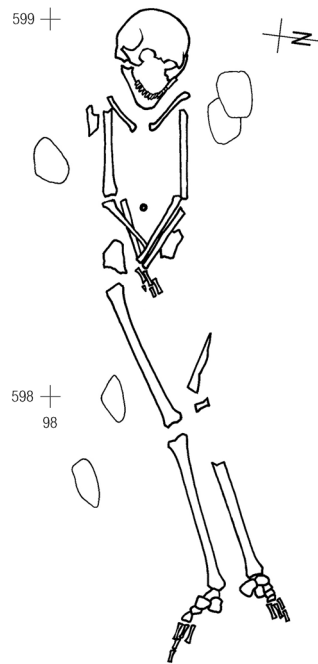

Grab 358

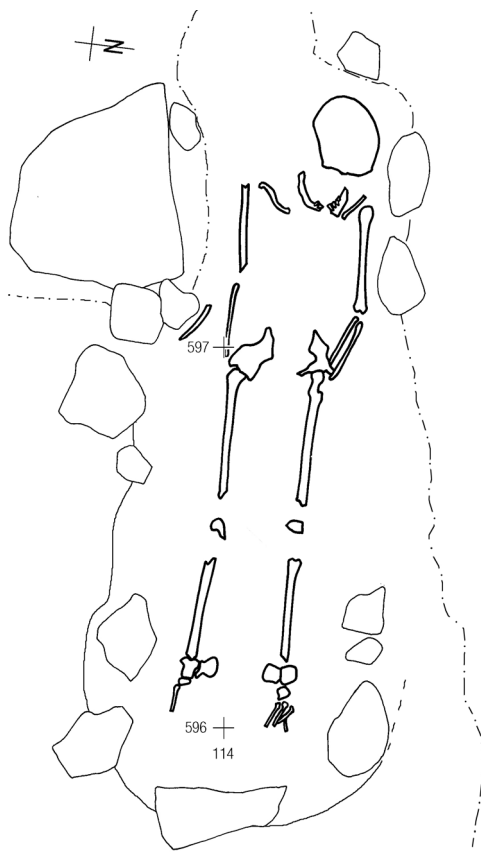

Grab 360

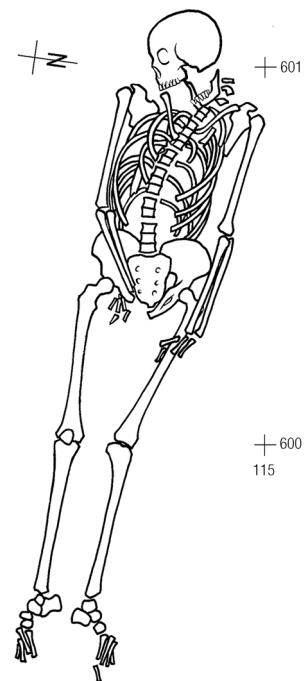

Grab 361

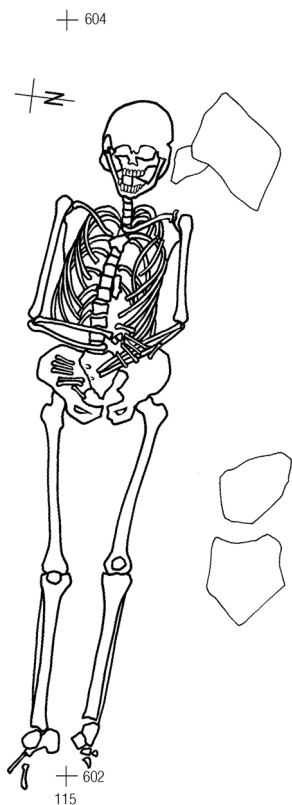

Gräber 362/364/369

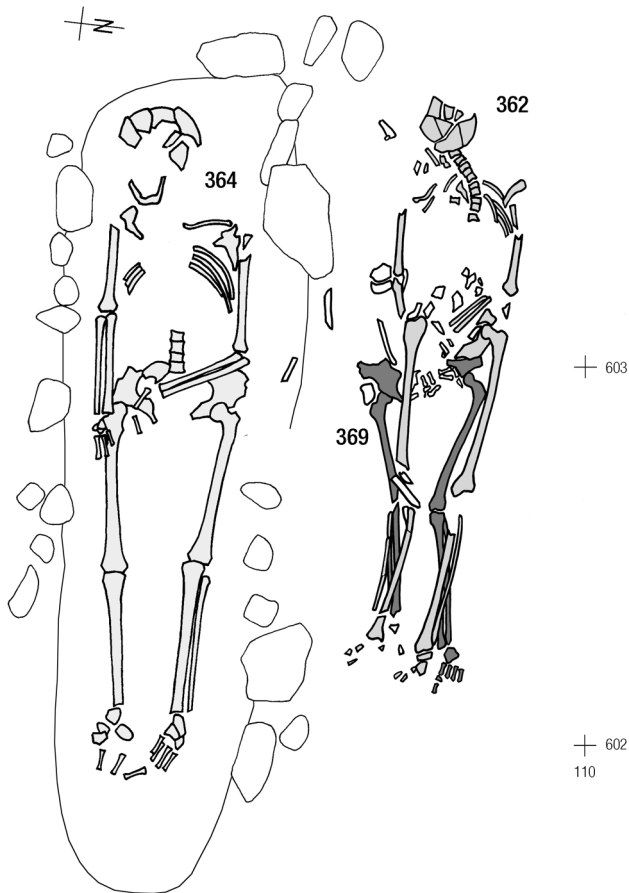

Grab 363

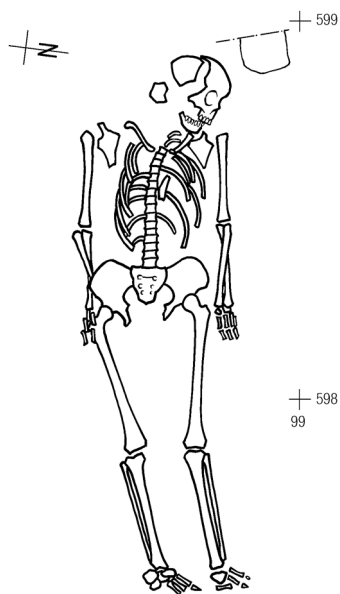

Grab 367

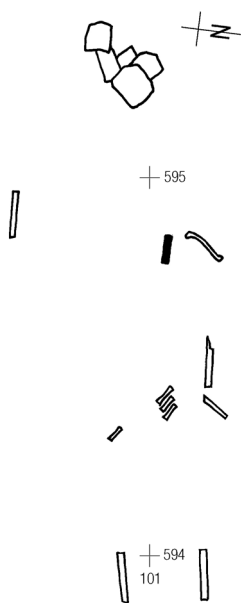

Grab 368

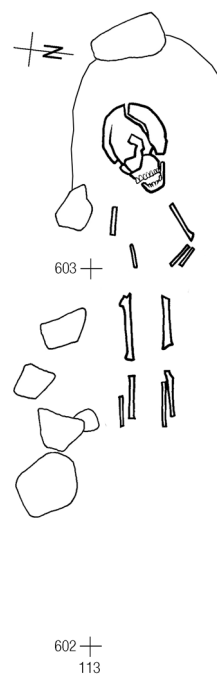

Grab 370

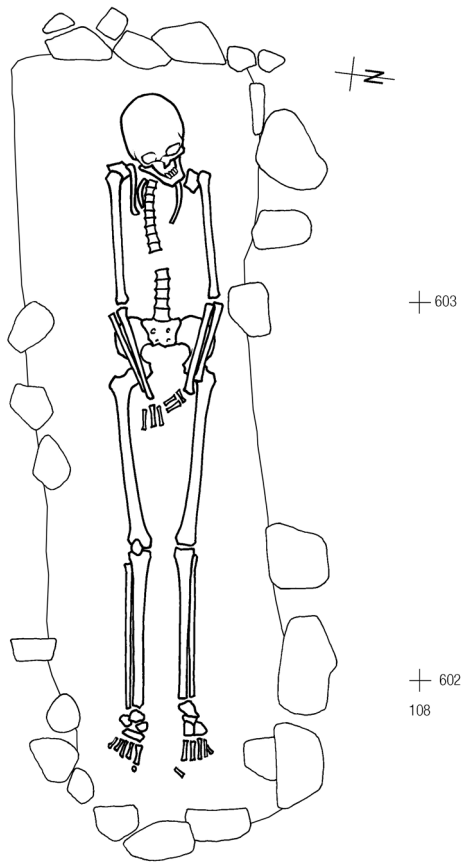

Grab 372

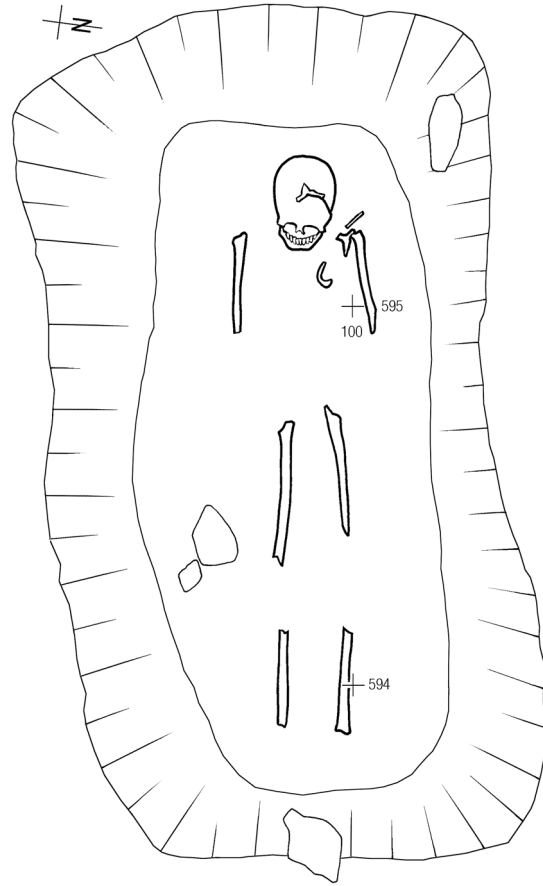

Grab 371

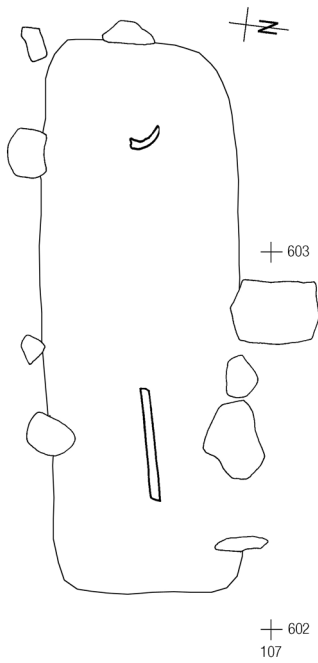

Grab 374



Grab 375

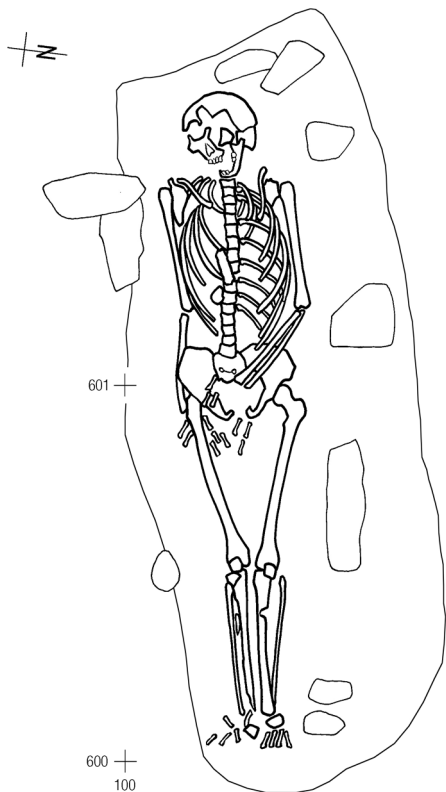

Grab 376

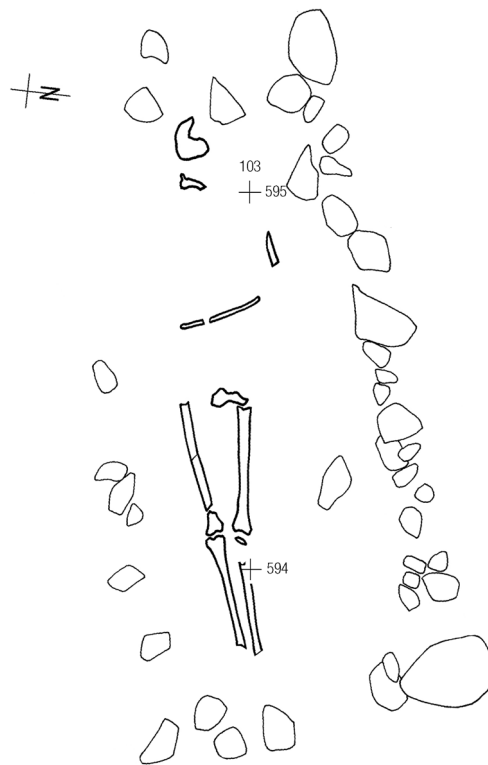

Grab 377

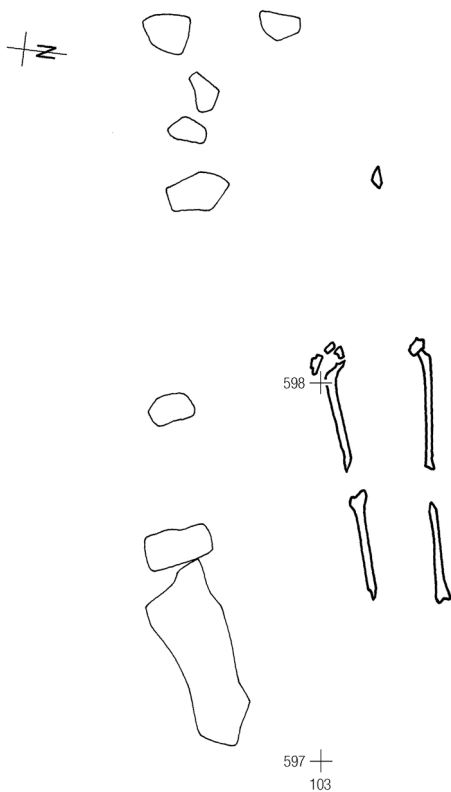

Grab 378

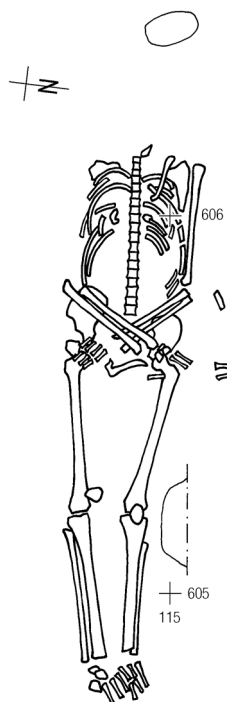

Grab 379

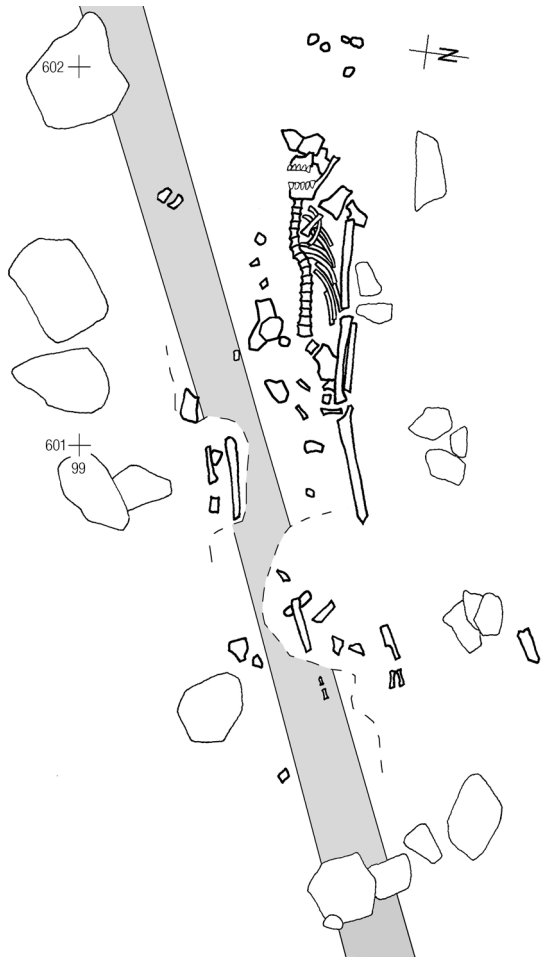

Grab 380

